

Beam-Deflection Tube

9-PIN MINIATURE TYPE

For Use in Balanced-Modulator, Balanced Mixer, and Frequency-Converter Applications in Single- and Double-Sideband, Suppressed-Carrier Communication Equipment Operating at Frequencies up to 100 Mc

GENERAL DATA

Electrical:

Heater, for Unipotential Cathode:		
Voltage (AC or DC)	6.3 ± 10%	volts
Current	0.35	amp
Direct Interelectrode Capacitances (Approx.):*		
Grid No.1 to all other electrodes except plate.	7.5	μf
Grid No.1 to deflecting electrode No.1.	0.015	μf
Grid No.1 to deflecting electrode No.2.	0.015	μf
Grid-No.1 to plate No.1	0.003	μf
Grid No.1 to plate No.2	0.003	μf
Plate No.1 to all other electrodes except deflecting electrode No.1.	0.8	μf
Plate No.2 to all other electrodes except deflecting electrode No.2.	0.8	μf
Plate No.1 to plate No.2.	0.3	μf
Deflecting electrode No.1 to all other electrodes except plate No.1.	4.6	μf
Deflecting electrode No.2 to all other electrodes except plate No.2.	4.6	μf
Deflecting electrode No.1 to plate No.1	4	μf ←
Deflecting electrode No.2 to plate No.2	4	μf ←
Deflecting electrode No.1 to deflecting electrode No.2	1.4	μf
Characteristics, Class A₁ Amplifier:		
Plate-No.1 Supply Voltage	150	volts
Plate-No.2 Supply Voltage	150	volts
Deflecting-Electrode-No.1 Supply Voltage	25	volts
Deflecting-Electrode-No.2 Supply Voltage	25	volts
Grid-No.2 Supply Voltage.	175	volts
Cathode Resistor.	150	ohms
Total Beam Current (Plate-No.1 current plus plate-No.2 current).	8.5	ma ←
Grid-No.2 Current	2.1	ma ←

← Indicates a change.



7360

Transconductance:

Grid No.1 to both plates			
→ connected together.	5400	μ hos	
Deflecting electrode No.1			
→ to plate No.1 ^b	800	μ hos	
Deflecting electrode No.2			
→ to plate No.2 ^b	800	μ hos	
Switching Voltage ^c	11	volts	

Mechanical:

Operating Position.	Any
Maximum Overall Length.	2-5/8"
Maximum Seated Length	2-3/8"
Length, Base Seat to Bulb Top (Excluding tip)	2" \pm 3/32"
Diameter.	0.750" to 0.875"
Dimensional Outline	See <i>General Section</i>
Bulb.	T6-1/2
Base.	Small-Button Noval 9-Pin (JEDEC No.E9-1)
Basing Designation for BOTTOM VIEW.	9KS

- Pin 1 - Cathode,
Internal
Shield
- Pin 2 - Grid No.2
- Pin 3 - Grid No.1
- Pin 4 - Heater
- Pin 5 - Heater

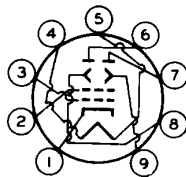

- Pin 6 - Plate No.2
- Pin 7 - Plate No.1
- Pin 8 - Deflecting
Electrode
No.2
- Pin 9 - Deflecting
Electrode
No.1

BALANCED MODULATOR

Maximum Ratings, Absolute-Maximum Values:

PLATE-No.1 VOLTAGE.	300	max.	volts
PLATE-No.2 VOLTAGE.	300	max.	volts
DEFLECTING-ELECTRODE-No.1 VOLTAGE	\pm 100	max.	volts
DEFLECTING-ELECTRODE-No.2 VOLTAGE	\pm 100	max.	volts
GRID-No.2 (SCREEN-GRID) VOLTAGE	250	max.	volts
GRID-No.2 INPUT	0.5	max.	watt
PLATE-No.1 DISSIPATION.	1.5	max.	watts
PLATE-No.2 DISSIPATION.	1.5	max.	watts
PEAK HEATER-CATHODE VOLTAGE:			
Heater negative with			
respect to cathode.	180	max.	volts
Heater positive with			
respect to cathode.	180 ^d	max.	volts

Typical Operation:

In accompanying balanced-modulator circuit utilizing separate excitation^e

Plate Voltage (Each plate).	150	volts
Deflecting-Electrode Voltage (Approx., each electrode)	25	volts
Grid-No.2 Voltage	175	volts

→ Indicates a change.



7360

	Cathode Resistor.	1200	ohms
(Peak-to-Peak AF Deflecting- Electrode Voltage ^f	2.8	volts
	Peak-to-Peak RF Grid-No.1 Voltage	10	volts
	Plate Current (Each plate).	1.5	ma
	Grid-No.2 Current	0.75	ma
	Plate-to-Plate Load Impedance (Approx.)	5000	ohms
(Push-Pull, Peak-to-Peak Double- Sideband Output Voltage	4	volts
	Carrier Suppression ^g	60	db ←
	Third-Order Distortion ^g	-47	db
	Fourth-Order Distortion ^g	-45	db

Maximum Circuit Values:

(Grid-No.1-Circuit Resistance: For fixed-bias operation.	0.5	max. megohm
	For cathode-bias operation.	2.2	max. megohms
	Deflecting-Electrode-Circuit Resistance (Per deflecting electrode).	0.05	max. megohm

BALANCED MIXER

Maximum Ratings, Absolute-Maximum Values:

	PLATE-No.1 VOLTAGE.	300	max. volts
	PLATE-No.2 VOLTAGE.	300	max. volts
	DEFLECTING-ELECTRODE-No.1 VOLTAGE	±100	max. volts
	DEFLECTING-ELECTRODE-No.2 VOLTAGE	±100	max. volts
	GRID-No.2 (SCREEN-GRID) VOLTAGE	250	max. volts
	GRID-No.2 INPUT	0.5	max. watt
	PLATE-No.1 DISSIPATION.	1.5	max. watts
	PLATE-No.2 DISSIPATION.	1.5	max. watts
	PEAK HEATER-CATHODE VOLTAGE:		
(Heater negative with respect to cathode.	180	max. volts
	Heater positive with respect to cathode.	180 ^d	max. volts

Typical Operation:

In accompanying balanced-mixer circuit utilizing separate excitation^e

(Plate Voltage (Each plate).	150	volts
	Deflecting-Electrode Voltage (Approx., each electrode)	25	volts
	Grid-No.2 Voltage	175	volts
	Cathode Resistor.	1200	ohms
	Peak-to-Peak Single-Sideband Deflecting-Electrode Voltage ^f	8	volts
(Peak-to-Peak RF Grid-No.1 Voltage	10	volts
	Plate Current (Each plate).	1.5	ma
	Grid-No.2 Current	0.75	ma

← Indicates a change.



7360

Plate-to-Plate Load Impedance (Approx.)	10000	ohms
Push-Pull, Peak-to-Peak Single-Sideband Output Voltage	40	volts
Oscillator Rejection ^g	-40	db
Third-Order Distortion ^g	-40	db
Fourth-Order Distortion ^g	-39	db

Maximum Circuit Values:

Grid-No.1-Circuit Resistance: For fixed-bias operation	0.5 max.	megohm
For cathode-bias operation	2.2 max.	megohms
Deflecting-Electrode-Circuit Resistance (Per deflecting electrode)	0.05 max.	megohm

^a Without external shield.

^b Defined as the partial derivative of the plate current with respect to the difference between the deflecting-electrode voltages, evaluated about the point of equal plate currents.

^c Defined as the sum of (a) the absolute value of the difference between the deflecting-electrode voltages when the current to one plate is equal to 90% of the total beam current and (b) the absolute value of the difference between the deflecting-electrode voltages when the current to the same plate is equal to 10% of the total beam current. This sum, expressed in terms of signal voltage, corresponds to the peak-to-peak value of signal voltage that is required between the deflecting electrodes to produce peak-to-peak signal current at either plate equal to 80% of the total beam current.

^d The dc component must not exceed 100 volts.

^e Operation with self-excitation and cathode resistor of 300 ohms is similar to operation with separate excitation.

^f To either deflecting electrode. The other deflecting electrode is bypassed.

^g Referred to single-sideband output voltage.

OPERATING CONSIDERATIONS

Deflecting-electrode-circuit resistance should be kept below 0.05 megohm to prevent nonlinear tube operation. The resistances of the two deflecting-electrode circuits should be approximately equal to minimize unbalance. The current drawn by each *deflecting-electrode* is in the order of 40 microamperes.

Magnetic fields adversely affect the intrinsic operating plate-current balance of the 7360. Although this tube is internally shielded to minimize this effect, the tube should be mounted as far as possible from all devices producing extraneous magnetic fields such as transformers, chokes, motors, or similar components. It is recommended that an external shield be used in those applications critical for balance.

Chassis layout should be such that all components and wiring associated with the plates and deflecting electrodes is symmetrical. This consideration is particularly important in rf applications where very small differences in stray capacitance can result in unbalance. Chassis layouts which permit heat or vibration to affect the components associated with one deflecting-electrode circuit or plate circuit more than the other, should be avoided. All components should be rigidly mounted.



7360

BALANCED-MODULATOR CIRCUIT With Separate Excitation

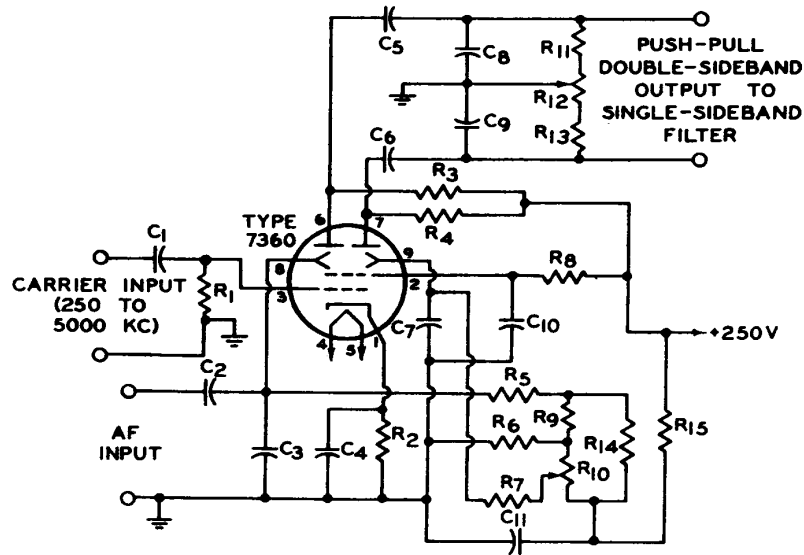

92CS-10258

- | | |
|--|---|
| C_1 : 0.001 μ f | R_6 : 12000 ohms |
| C_2 : 0.22 μ f | R_7 : 47000 ohms |
| C_3 : 0.001 μ f | R_8 : 0.1 megohm |
| C_4 : 0.01 μ f | R_9 : 2700 ohms |
| C_5 C_6 : 0.0033 μ f | R_{10} : Carrier-Balance Potentiometer, 5000 ohms |
| C_7 : 0.1 μ f | R_{11} : 2700 ohms |
| C_8 C_9 : Sufficient to resonate input of SSB filter | R_{12} : Quadrature-Balance Potentiometer, 2500 ohms |
| C_{10} : 0.22 μ f | R_{13} R_{14} : 2700 ohms |
| C_{11} : 0.47 μ f | R_{15} : 0.1 megohm |
| R_1 : 0.47 megohm | NOTE: All resistors 1/2 watt, \pm 10% unless specified. |
| R_2 : 1200 ohms | All capacitors 400 volts. |
| R_3 R_4 : 68000 ohms | |
| R_5 : 47000 ohms | |

Information furnished by RCA is believed to be accurate and reliable. However, no responsibility is assumed by RCA for its use; nor for any infringements of patents or other rights of third parties which may result from its use. No license is granted by implication or otherwise under any patent or patent rights of RCA.



7360

BALANCED-MIXER CIRCUIT With Separate Excitation

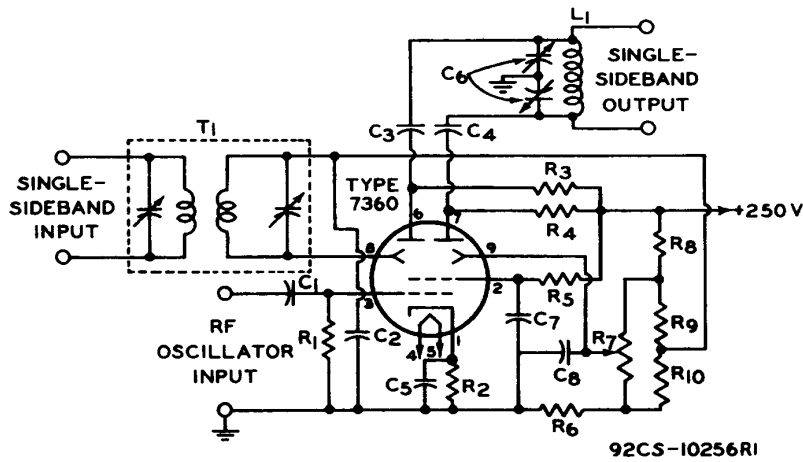

- | | |
|--|--|
| C_1 : 0.001 μ f | R_5 : 0.1 megohm |
| C_2 : 0.04 μ f | R_6 : 12000 ohms |
| C_3 C_4 : 0.001 μ f | R_7 : Oscillator-Rejection Potentiometer, 5000 ohms |
| C_5 : 0.04 μ f | R_8 : 0.1 megohm |
| C_6 : Split-Stator Tuning Capacitor to Resonate with L_1 | R_9 R_{10} : 2700 ohms |
| C_7 C_8 : 0.04 μ f | T_1 : Tuned Input Transformer |
| L_1 : Inductor | NOTE: All resistors 1/2 watt, \pm 10%, unless specified. |
| R_1 : 0.47 megohm | All capacitors 400 volts. |
| R_2 : 1200 ohms | |
| R_3 R_4 : 68000 ohms | |

Information furnished by RCA is believed to be accurate and reliable. However, no responsibility is assumed by RCA for its use; nor for any infringements of patents or other rights of third parties which may result from its use. No license is granted by implication or otherwise under any patent or patent rights of RCA.

AVERAGE CHARACTERISTICS

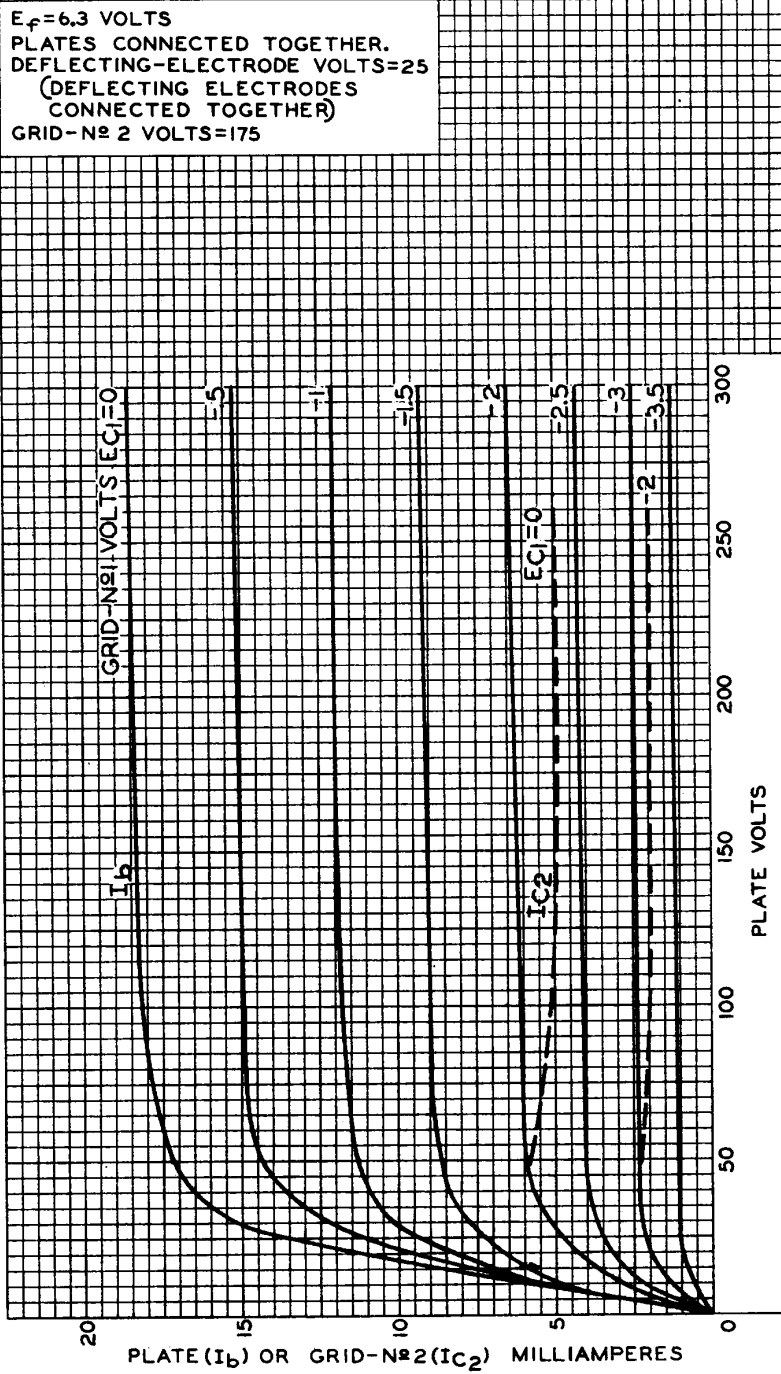

92CM-10253RI



7360

AVERAGE CHARACTERISTICS

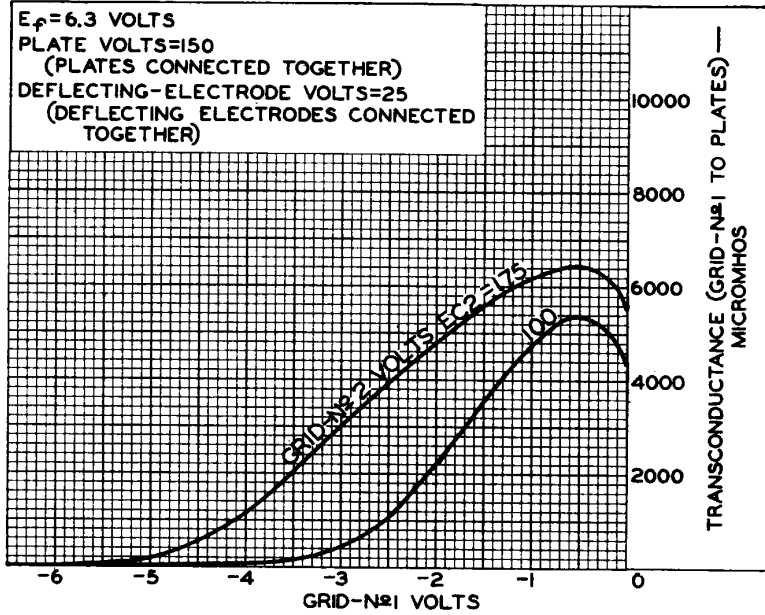

92CS-10250R2

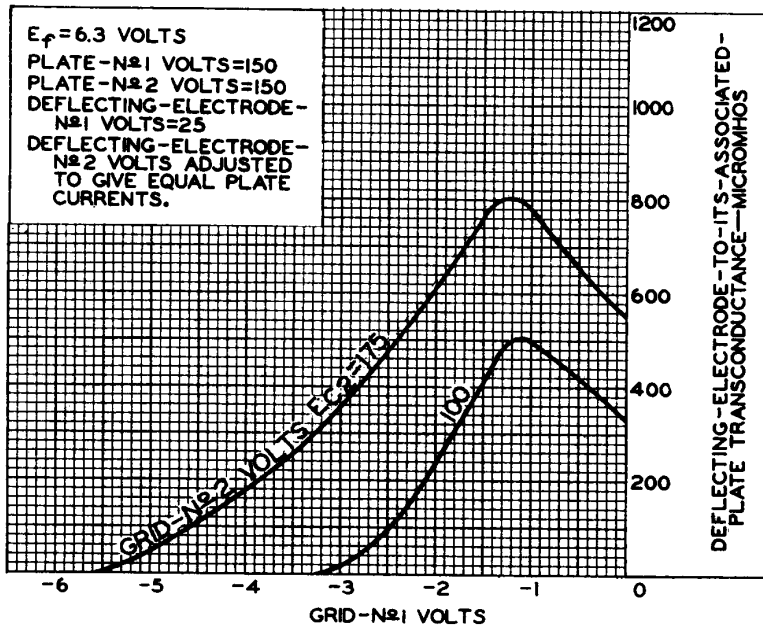

92CS-10249R1

RADIO CORPORATION OF AMERICA
 Electron Tube Division

Harrison, N. J.



AVERAGE CHARACTERISTICS

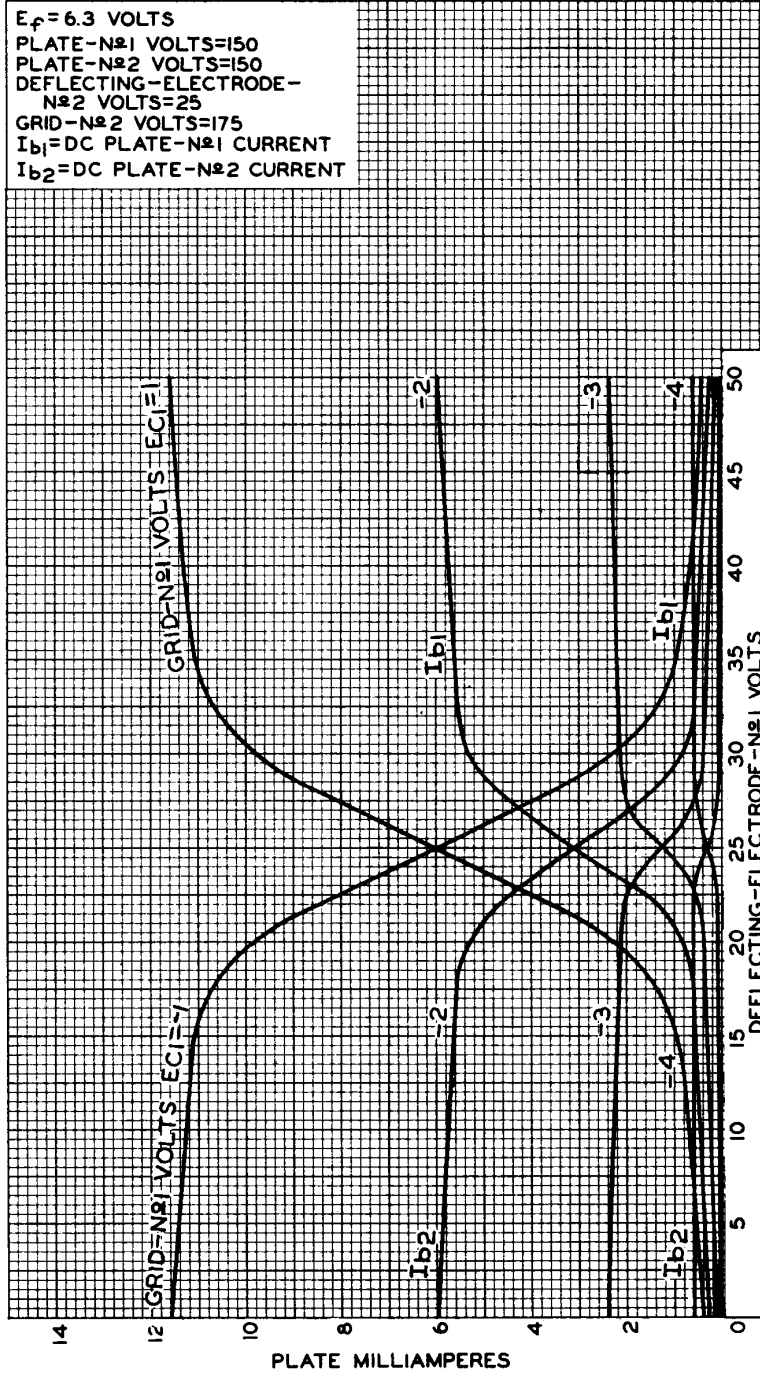

92CM-10252R2



OPERATION CHARACTERISTICS

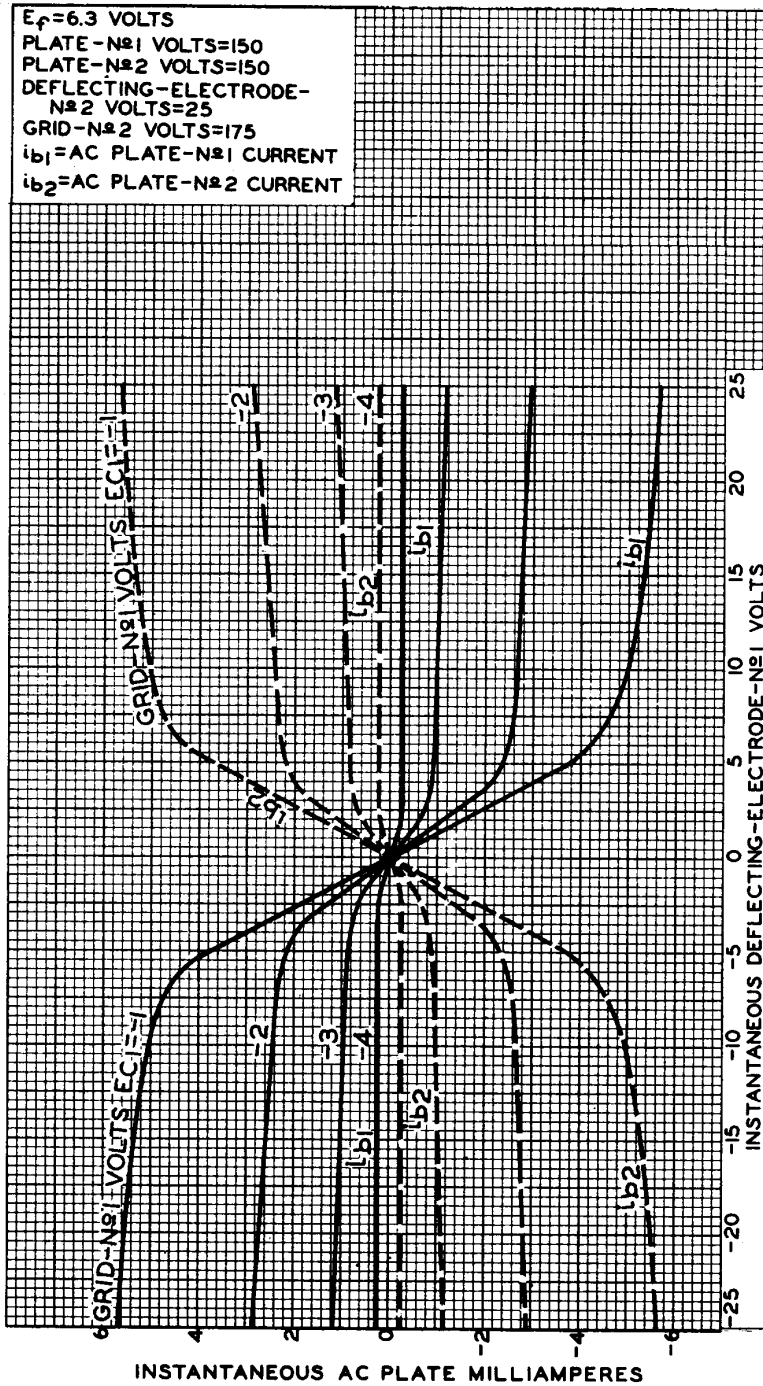

92CM-10264R2

