



6386
TWIN TRIODE
 Five-Star Tube
 ★ ★ ★ ★ ★

FOR REMOTE-CUTOFF CASCODE-AMPLIFIER APPLICATIONS

REMOTE-CUTOFF CHARACTERISTIC
9-PIN MINIATURE

SHOCK, VIBRATION RATINGS
HEATER-CYCLING RATING

MEDIUM-MU

DESCRIPTION AND RATING

The 6386 is a miniature medium-mu twin triode in which each section exhibits a remote-cutoff characteristic. It is designed primarily for use as a cascode radio-frequency amplifier, intermediate-frequency amplifier, or mixer in circuits to which it is desired to apply automatic-gain-control. When used in cascode applications, the performance of the 6386 is characterized by high gain, low noise figure, and low higher-order harmonic distortion.

The 6386 is a special-quality tube intended for use in critical industrial and military applications in which operational dependability is of primary importance. Features of the tube include a high degree of mechanical strength and a heater-cathode construction capable of withstanding many-thousand cycles of intermittent operation. When used in on-off control applications, the tube will maintain its emission capabilities after long periods of operation under cutoff conditions.

BASING DIAGRAM

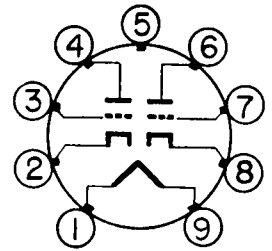

RETMA 8CJ

TERMINAL CONNECTIONS

- Pin 1—Heater
 - Pin 2—Cathode (Section 2)
 - Pin 3—Grid (Section 2)
 - Pin 4—Plate (Section 2)
 - Pin 5—Internal Shield†
 - Pin 6—Plate (Section 1)
 - Pin 7—Grid (Section 1)
 - Pin 8—Cathode (Section 1)
 - Pin 9—Heater
- † It is recommended that Pin 5 be grounded.

GENERAL

ELECTRICAL

Cathode—Coated Unipotential	
Heater Voltage, AC or DC	6.3 ± 10% Volts
Heater Current	0.35 Amperes
Direct Interelectrode Capacitances*	
Grid to Plate, Each Section	1.2 μμf
Input, Each Section	2.0 μμf
Output, Each Section	1.1 μμf
Heater to Cathode, Each Section	2.6 μμf
Grid to Grid	0.003 μμf
Plate to Plate	0.11 μμf

*Without external shield.

MECHANICAL

- Mounting Position—Any
- Envelope—T-6 1/2, Glass
- Base—E9-1, Small Button 9-Pin

PHYSICAL DIMENSIONS

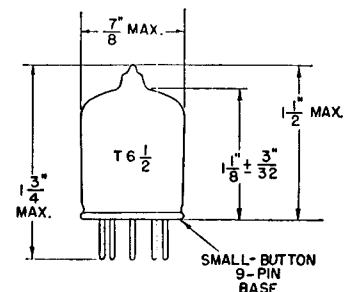

RETMA 6-1

MAXIMUM RATINGS

DESIGN-CENTER VALUES, EACH SECTION

Plate Voltage	300 Volts
Plate Dissipation	1.5 Watts
DC Cathode Current	18 Milliamperes
Heater-Cathode Voltage‡	
Heater Positive with Respect to Cathode	90 Volts
Heater Negative with Respect to Cathode	90 Volts

‡ When the 6386 is used as a cascode amplifier and the two sections are connected in series, the heater-cathode voltage of the grounded-grid stage may be as high as 250 volts maximum with the heater negative with respect to the cathode.

CHARACTERISTICS AND TYPICAL OPERATION

CLASS A₁ AMPLIFIER, EACH SECTION

Plate Voltage	100 Volts
Cathode-Bias Resistor	200 Ohms
Amplification Factor	17
Plate Resistance, approximate	4250 Ohms
Transconductance	4000 Micromhos
Plate Current	9.6 Milliamperes
Grid Voltage, approximate	
G _m = 100 Micromhos	-16 Volts

CASCODE AMPLIFIER—SEE CIRCUIT DIAGRAM

Plate-Supply Voltage	300	200	Volts
Plate Load Resistor	10000	0	Ohms
Voltage-Divider Supply Voltage	250	200	Volts
Grid-Supply Voltage	-5	-2	Volts
Cascode Transconductance	4000	4000	Micromhos
Cascode Plate Current	10.5	10.5	Milliamperes
Third Harmonic Distortion			
E _{sig} = 1.0 Volts, Peak	0.5	Percent

SPECIAL TESTS AND RATINGS

Inoperatives Control

Minimum continuous operating time under life-test conditions or equivalent for all tubes prior to characteristics testing

	46 Hours
--	----------

Heater-Cycling Rating

Cycles of Intermittent Operation, minimum

	2000 Cycles
--	-------------

E_f = 7.5 volts cycled for one minute on and one minute off. E_b = E_c = 0 volts. E_{hk} = 135 volts with heater positive with respect to cathode.

Shock Rating

Impact Acceleration in Any Direction

	600 G
--	-------

Forces as applied by the Navy-type, High Impact (flyweight) Shock Machine for Electronic Devices or its equivalent.

Fatigue Rating

Vibrational Acceleration in Any Direction

	2.5 G
--	-------

Vibrational forces for a period of at least 100 hours at a frequency of 25 cycles per second.

AVERAGE TRANSFER CHARACTERISTICS

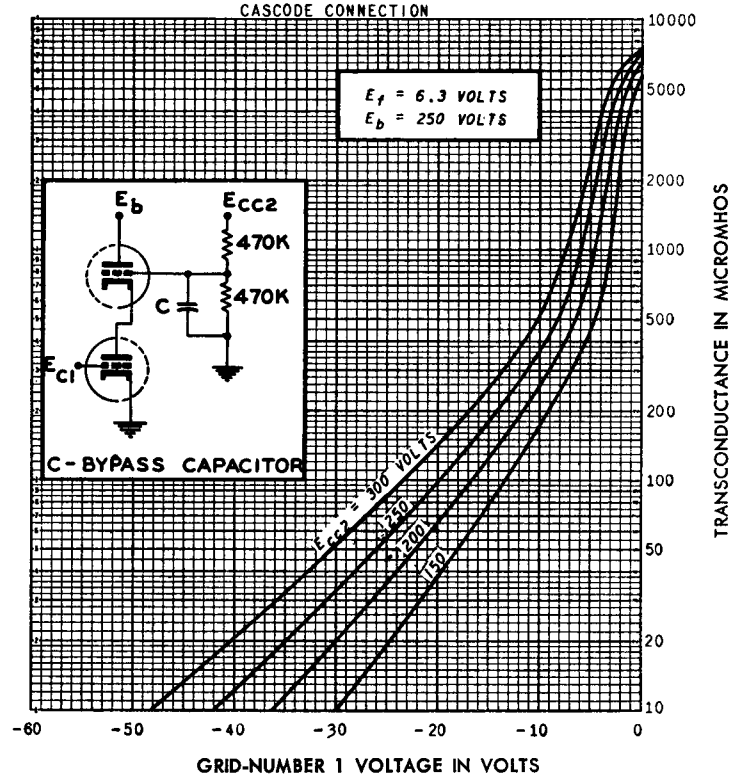

AUGUST 21, 1953

AVERAGE CHARACTERISTICS

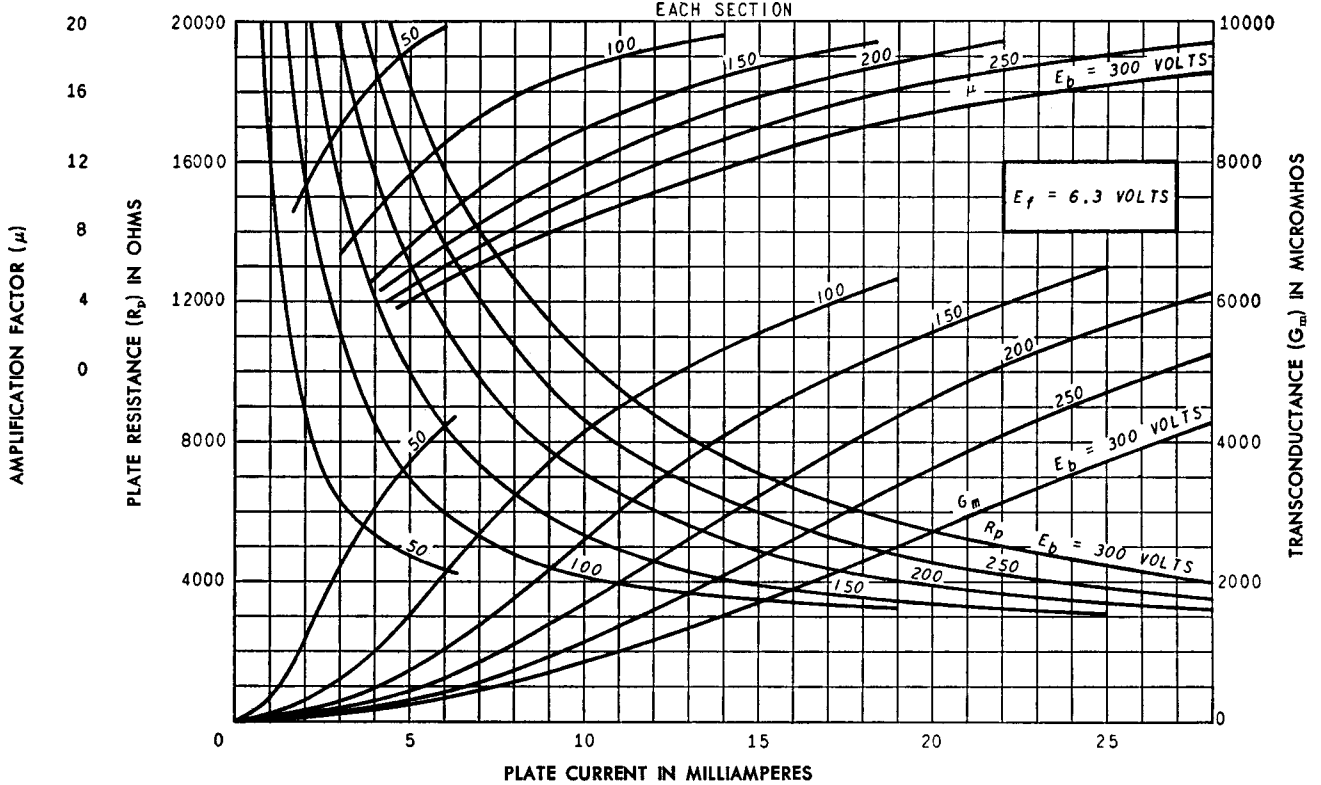

AUGUST 21, 1953

AVERAGE TRANSFER CHARACTERISTICS

CASCADE CONNECTION

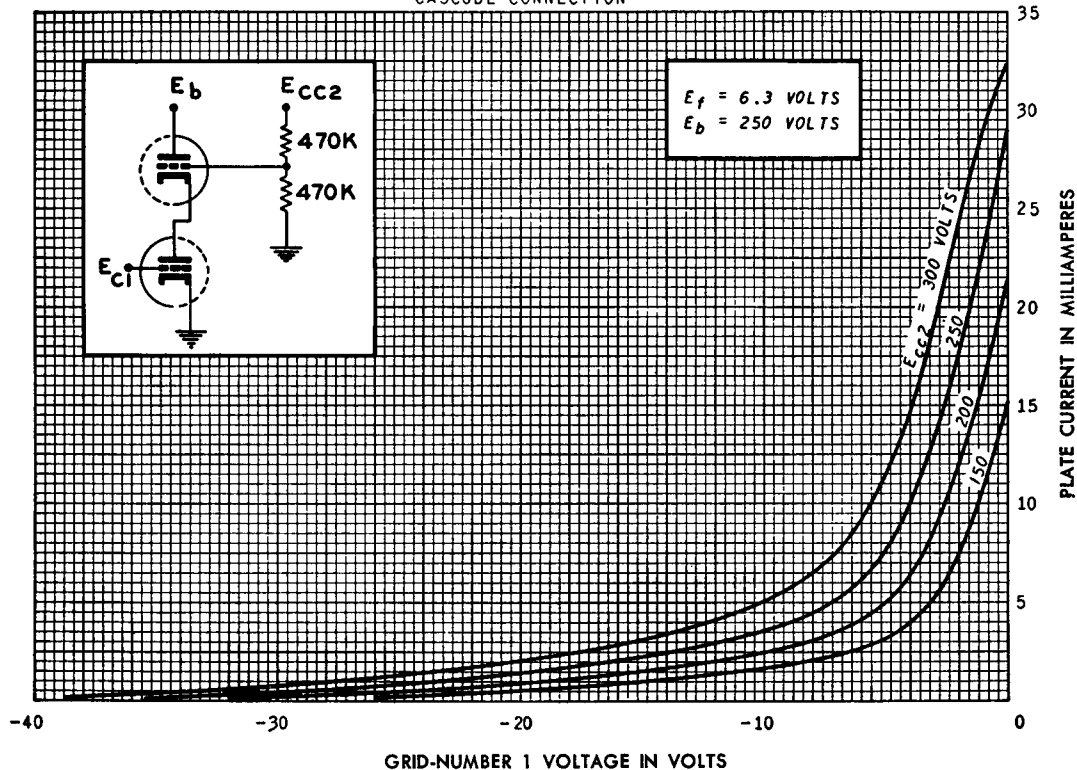

AUGUST 21, 1953

AVERAGE TRANSFER CHARACTERISTICS

EACH SECTION

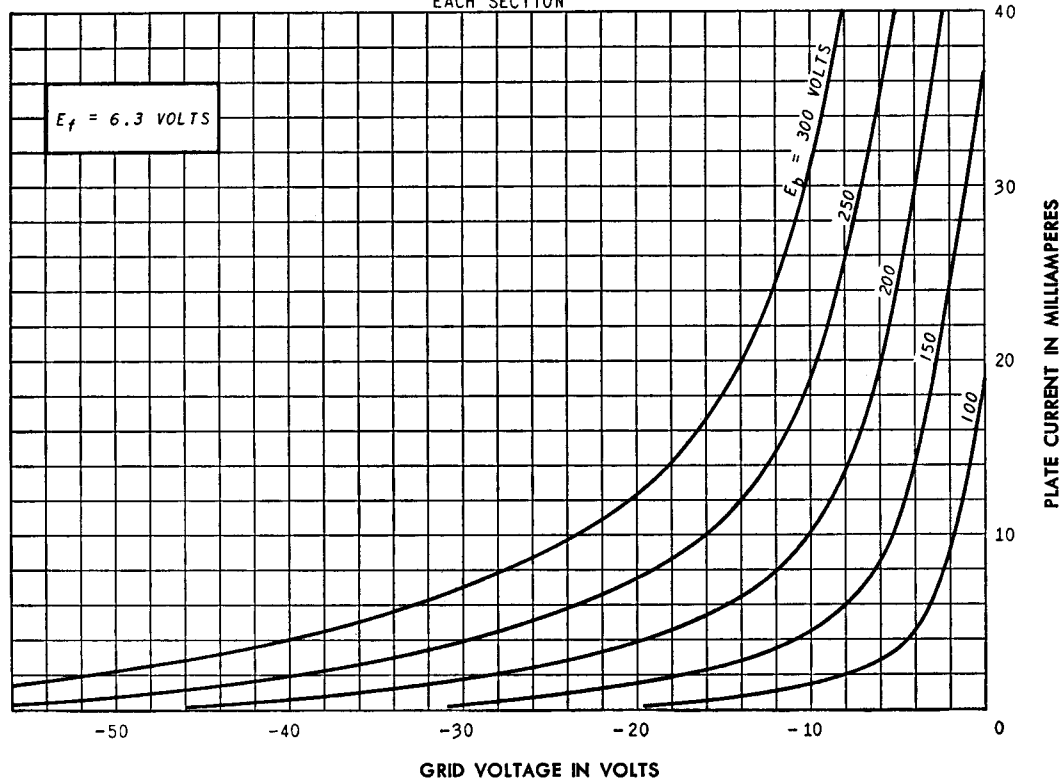

AUGUST 21, 1953

AVERAGE PLATE CHARACTERISTICS
 CASCADE CONNECTION

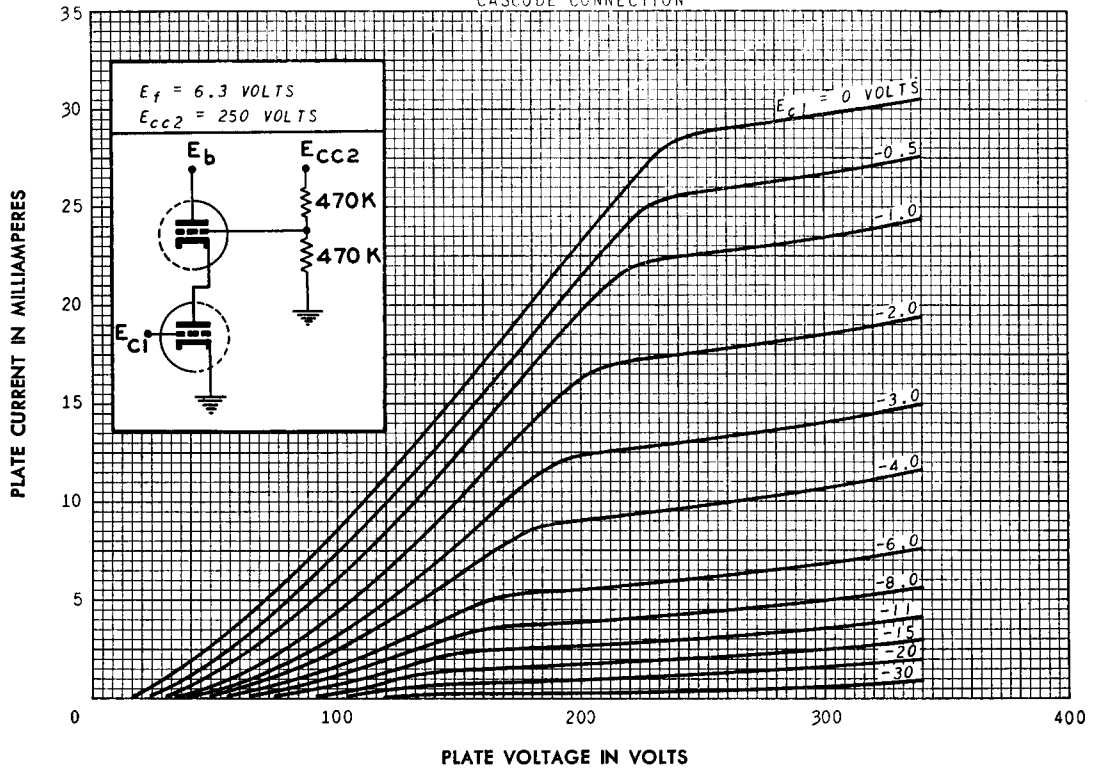

AUGUST 21, 1953

AVERAGE PLATE CHARACTERISTICS
 EACH SECTION

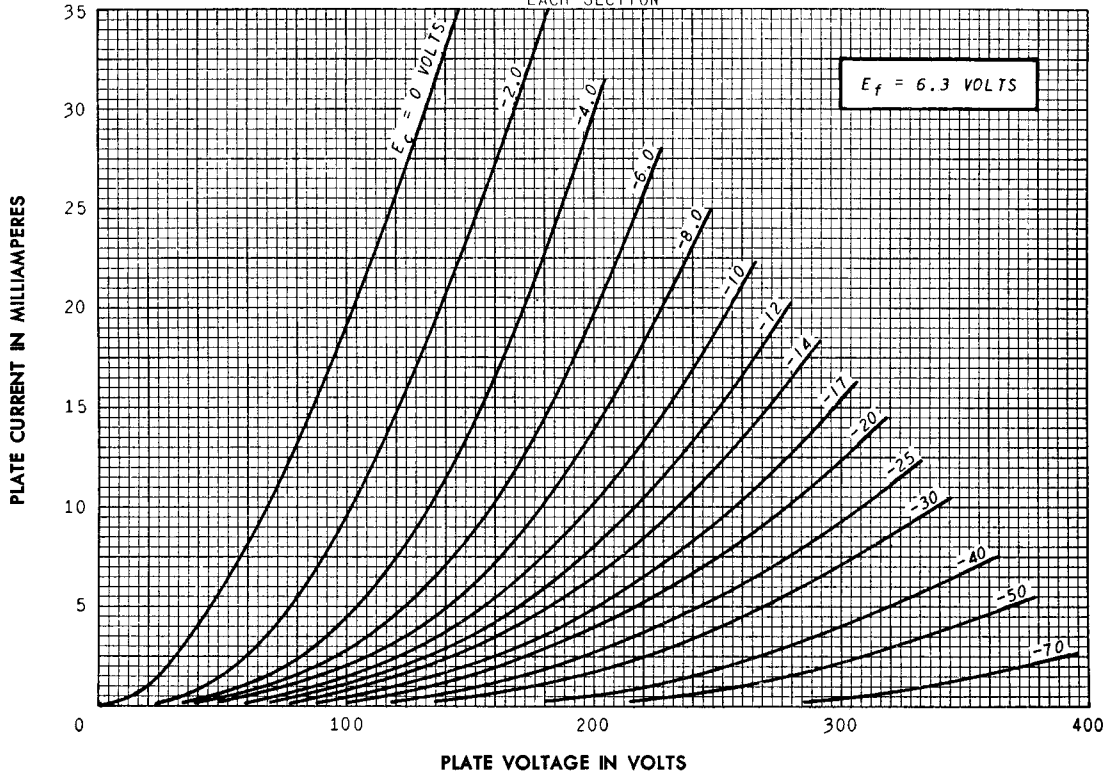

AUGUST 21, 1953

TYPICAL CIRCUIT FOR CASCODE OPERATION

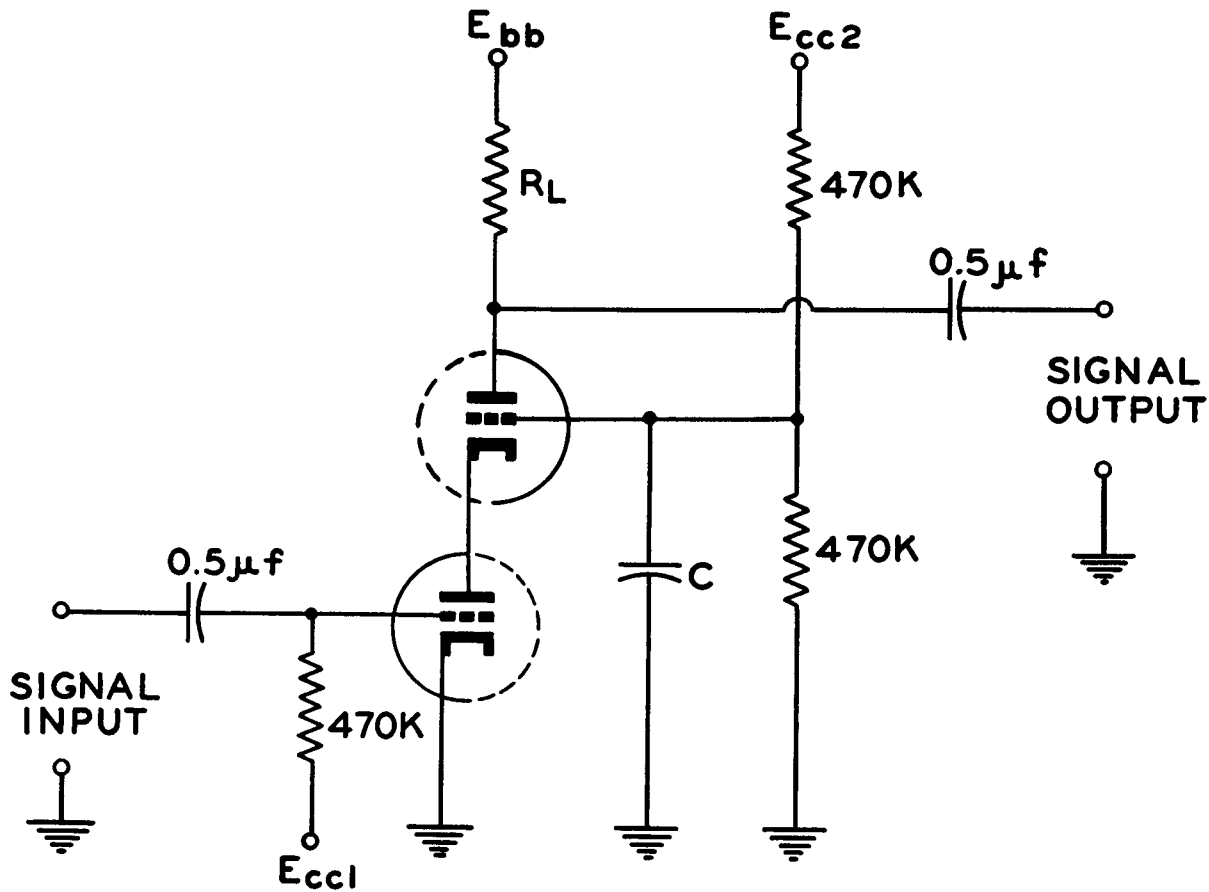

C - BYPASS CAPACITOR