

TUNG-SOL

PENTODE

MINIATURE TYPE

UNIPOENTIAL CATHODE

HEATER
3.15 VOLTS 0.6±10% AMP.

AC OR DC

ANY MOUNTING POSITION

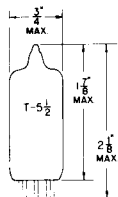

GLASS BULB

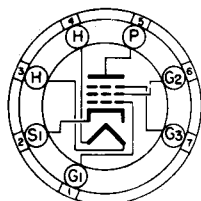

BOTTOM VIEW

SMALL-BUTTON MINIATURE
7 PIN BASE

TEM

THE 3DT6 IS A SHARP CUTOFF PENTODE IN THE 7 PIN MINIATURE CONSTRUCTION. IT IS INTENDED FOR USE AS AN FM DETECTOR IN 600 MA SERIES HEATER OPERATED TELEVISION RECEIVERS. DESIGNED SO THAT GRID #1 AND GRID #3 CAN EACH BE USED AS INDEPENDENT SHARP CUTOFF CONTROL ELECTRODES, THE TUBE MAY ALSO BE USED IN DELAY CIRCUITS, GAIN-CONTROLLED AMPLIFIER CIRCUITS, AND MIXER CIRCUITS. THERMAL CHARACTERISTICS OF THE HEATER ARE CONTROLLED SUCH THAT HEATER VOLTAGE SURGES DURING THE WARM-UP CYCLE ARE MINIMIZED PROVIDED IT IS USED WITH OTHER TYPES WHICH ARE SIMILARLY CONTROLLED. WITH THE EXCEPTION OF HEATER WARM-UP TIME AND HEATER CHARACTERISTICS, THE 3DT6 IS IDENTICAL TO THE 6DT6.

DIRECT INTERELECTRODE CAPACITANCES — APPROX.

WITH EXTERNAL SHIELD, #316, CONNECTED TO CATHODE

GRID #1 TO PLATE	0.02	uu f
GRID #1 TO GRID #3	0.1	uu f
GRID #3 TO ALL OTHER ELECTRODES	6.1	uu f
GRID #1 TO GRID #2, GRID #3, HEATER, AND INTERNAL SHIELD AND CATHODE	5.8	uu f
GRID #3 TO PLATE	1.4	uu f

RATINGS

INTERPRETED ACCORDING TO DESIGN MAXIMUM SYSTEM

FM DETECTOR SERVICE

HEATER VOLTAGE	3.15	VOLTS
MAXIMUM PLATE VOLTAGE	330 ←	VOLTS
MAXIMUM GRID #3 (SUPPRESSOR) VOLTAGE	28 ←	VOLTS
MAXIMUM GRID #2 SUPPLY VOLTAGE	330 ←	VOLTS
MAXIMUM GRID #2 (SCREEN) VOLTAGE	SEE RATING CHART	
MAXIMUM GRID #1 (CONTROL-GRID) VOLTAGE:		
POSITIVE BIAS VALUE	0	VOLTS
MAXIMUM PLATE DISSIPATION	1.7 ←	WATTS
MAXIMUM GRID #2 INPUT:		
FOR GRID #2 VOLTAGES UP TO 165 VOLTS	1.1 ←	WATTS
FOR GRID #2 VOLTAGES BETWEEN 165 AND 330 VOLTS	SEE RATING CHART	
MAXIMUM HEATER-CATHODE VOLTAGE:		
HEATER NEGATIVE WITH RESPECT TO CATHODE	200	VOLTS
HEATER POSITIVE WITH RESPECT TO CATHODE	200 ^A	VOLTS
HEATER WARM-UP TIME (APPROX.) *	11	SECONDS

^A THE DC COMPONENT MUST NOT EXCEED 100 VOLTS.

* HEATER WARM-UP TIME IS DEFINED AS THE TIME REQUIRED FOR THE VOLTAGE ACROSS THE HEATER TO REACH 80% OF ITS RATED VOLTAGE AFTER APPLYING 4 TIMES RATED HEATER VOLTAGE TO A CIRCUIT CONSISTING OF THE TUBE HEATER IN SERIES WITH A RESISTANCE OF VALUE 3 TIMES THE NOMINAL HEATER OPERATING RESISTANCE.

CONTINUED ON FOLLOWING PAGE

→ INDICATES A CHANGE.

TUNG-SOL

CONTINUED FROM PRECEDING PAGE

TYPICAL OPERATING CONDITIONS AND CHARACTERISTICS

CLASS A₁ AMPLIFIER

HEATER VOLTAGE	3.15	VOLTS
HEATER CURRENT	0.6±10%	AMP.
PLATE SUPPLY VOLTAGE	150	VOLTS
GRID #3 SUPPLY VOLTAGE	0	VOLTS
GRID #2 SUPPLY VOLTAGE	100	VOLTS
CATHODE-BIAS RESISTOR	560	OHMS
PLATE RESISTANCE (APPROX.)	0.15	MEGOHM
TRANSCONDUCTANCE:		
GRID #1 TO PLATE	800	μMOS
GRID #3 TO PLATE	515	μMOS
GRID #1 VOLTAGE (APPROX.) FOR PLATE CURRENT OF 10 μAMP	-4.5	VOLTS
GRID #3 VOLTAGE (APPROX.) FOR PLATE CURRENT OF 10 μAMP	-3.5	VOLTS
PLATE CURRENT	1.1	MA.
GRID #2 CURRENT	2.1	MA.

TYPICAL OPERATION IN THE ACCOMPANYING LOCKED-OSCILLATOR,
 QUADRATURE-GRID FM DETECTOR CIRCUIT
 AT A CARRIER FREQUENCY OF 4.5 MC:

INPUT SIGNAL TO GRID OF DRIVER TUBE	15	200	500	MV RMS
PLATE SUPPLY VOLTAGE	250	250	250	VOLTS
GRID #3 VOLTAGE (OBTAINED FROM A 560000-OHM RESISTOR)	-5	-6	-6.4	VOLTS
GRID #2 SUPPLY VOLTAGE	100	100	100	VOLTS
CATHODE-BIAS RESISTOR	560	560	560	OHMS
PLATE LOAD RESISTOR	0.27	0.27	0.27	MEGOHM
PLATE CURRENT	0.23	0.22	0.21	MA.
GRID #2 CURRENT	3.4	5.5	6	MA.
GRID #1 CURRENT	0.013	0.6	0.8	MA.
BANDWIDTH:				
FOR A TOTAL HARMONIC DISTORTION OF 10 PERCENT	65	120	118	KC
AM REJECTION (APPROX.) ^B	33	29	28	DB
AUDIO OUTPUT VOLTAGE (RMS, APPROX.):				
WITH ± 7.5-KC DEVIATION FROM MEAN VALUE OF 4.5 MC	5.5	6.5	7.5	VOLTS
WITH ± 25-KC DEVIATION FROM MEAN VALUE OF 4.5 MC	17	21	23	VOLTS
TOTAL HARMONIC DISTORTION:				
WITH ± 25-KC DEVIATION FROM MEAN VALUE OF 4.5 MC	2	3	4	PERCENT
SENSITIVITY:				
WITH ±7.5-KC DEVIATION FROM MEAN VALUE OF 4.5 MC			5 ^C	MILLIVOLTS
WITH ±25-KC DEVIATION FROM MEAN VALUE OF 4.5 MC			15 ^C	MILLIVOLTS
MAXIMUM CIRCUIT VALUES:				
GRID #1 CIRCUIT RESISTANCE; FOR FIXED-BIAS OPERATION			0.25	MEGOHM
FOR CATHODE-BIAS OPERATION			0.5	MEGOHM

^B RATIO OF THE AUDIO OUTPUT VOLTAGE PRODUCED BY 30-PERCENT AMPLITUDE MODULATION OF THE 4.5-MC CARRIER FREQUENCY TO THE AUDIO OUTPUT PRODUCED BY ± 25-KC DEVIATION FROM THE 4.5-MC CARRIER FREQUENCY, WITH A MODULATING FREQUENCY OF 400 CPS IN BOTH CASES.

^C SIGNAL LEVEL AT WHICH DETECTOR CIRCUIT WILL HANDLE THE INDICATED DEVIATION IN FREQUENCY FROM THE MEAN VALUE OF 4.5 MC, BEFORE DISTORTION OCCURS.

→ INDICATES A CHANGE.

TUNG-SOL

**LOCKED-OSCILLATOR, QUADRATURE-GRID DETECTOR CIRCUIT
UTILIZING TYPE 3DT6**

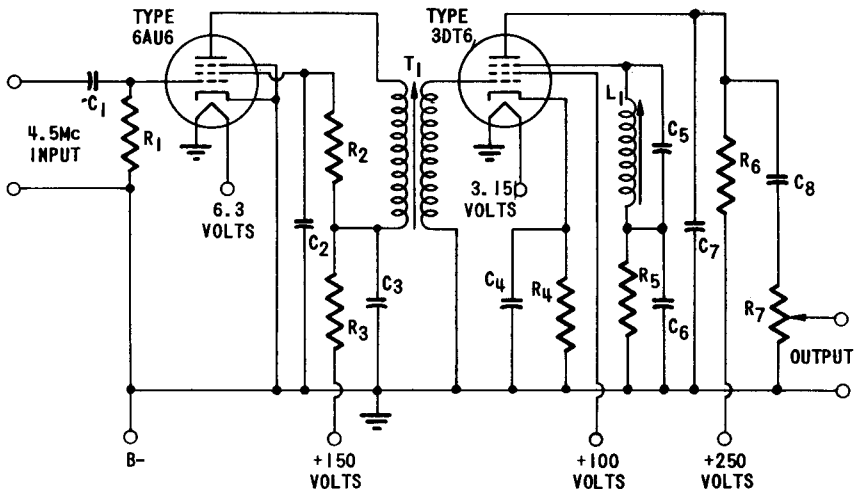

- C₁: 47μmf, 400 VOLTS
- C₂: 0.01μf, 400 VOLTS
- C₃: 0.01μf, 400 VOLTS
- C₄: 0.01μf, 200 VOLTS
- C₅: 18μmf, 200 VOLTS
- C₆: 0.05μf, 200 VOLTS
- C₇: 100 TO 1000μmf, 400 VOLTS
- C₈: 0.01μf, 400 VOLTS

- L₁: SLUG-TUNED INDUCTOR WITH Q OF 50 AND TUNEABLE TO 4.5-MC.
- R₁: 100000 OHMS, 0.5 WATT
- R₂: 12000 OHMS, 0.5 WATT
- R₃: 1000 OHMS, 0.5 WATT
- R₄: 560 OHMS, 0.5 WATT
- R₅: 560000 OHMS, 0.5 WATT

- R₆: 270000 OHMS, 0.5 WATT
- R₇: 0.5 MEGOHM POTENTIOMETER
- T₁: SLUG-TUNED, BIFILAR WOUND IF TRANSFORMER WITH RATIO OF 1:1.5, Q > 60, AND TUNEABLE TO 4.5-MC WITH TUBE AND WIRING CAPACITANCE.

PRINTED IN U. S. A.

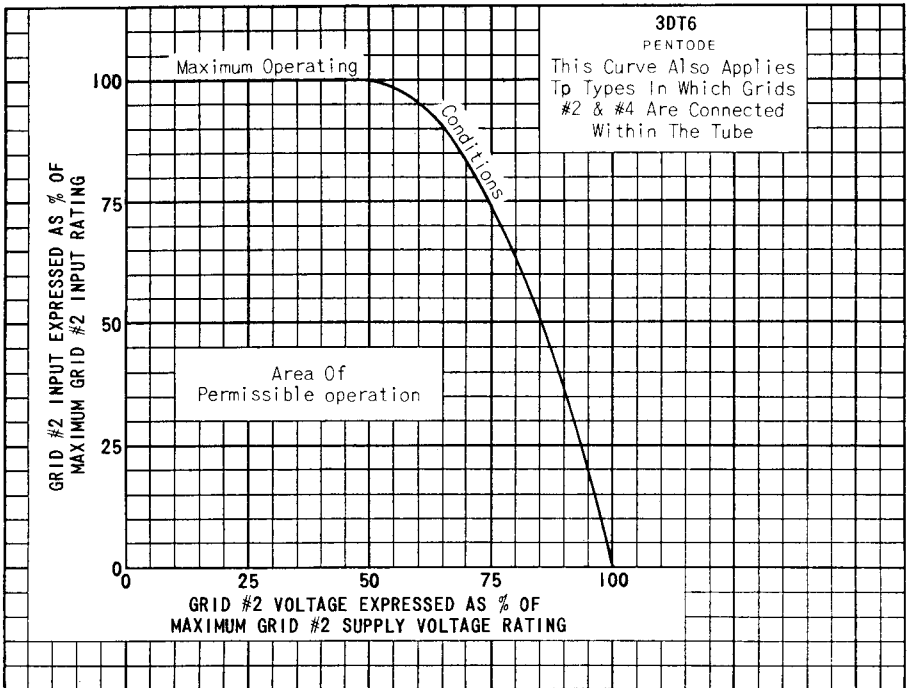
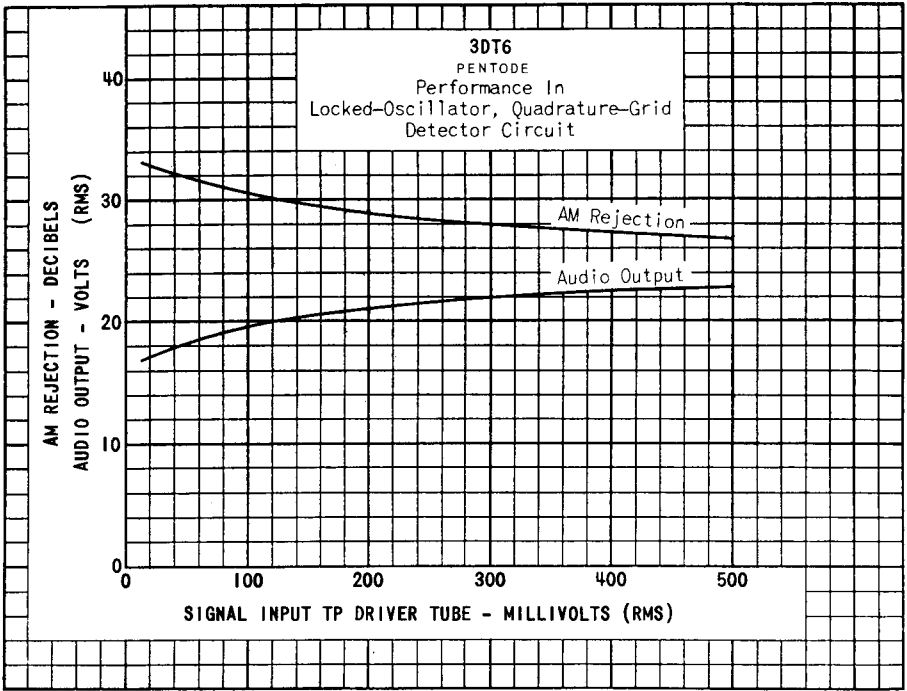

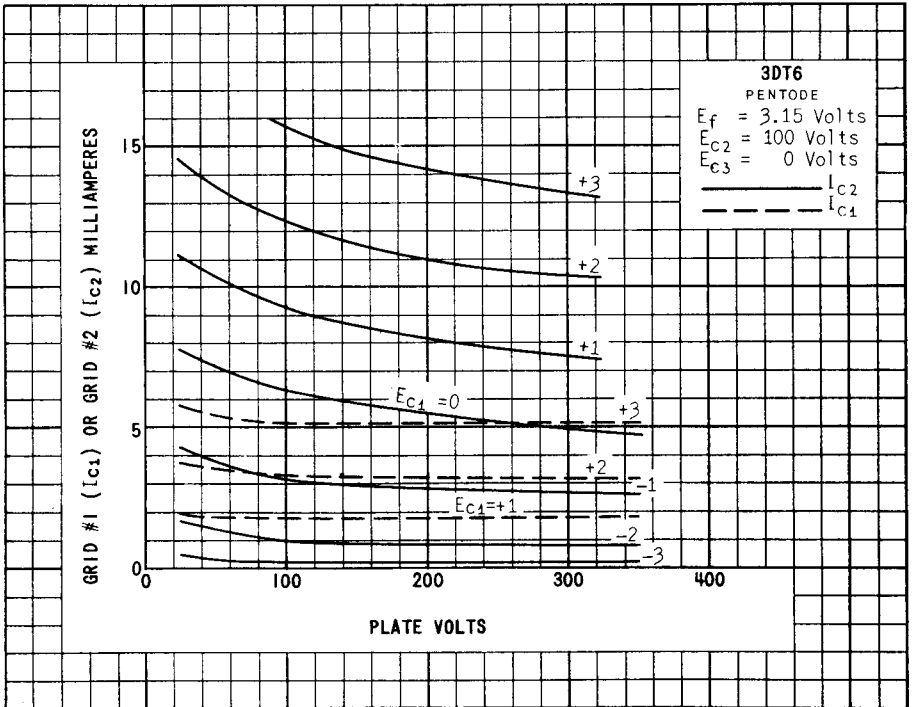
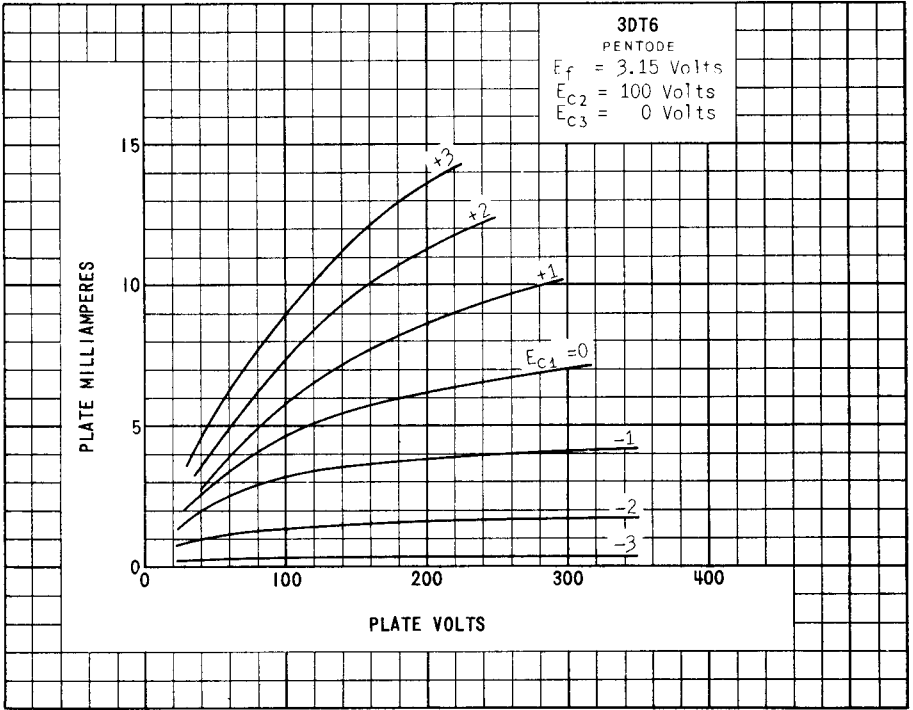

PRINTED IN U. S. A.

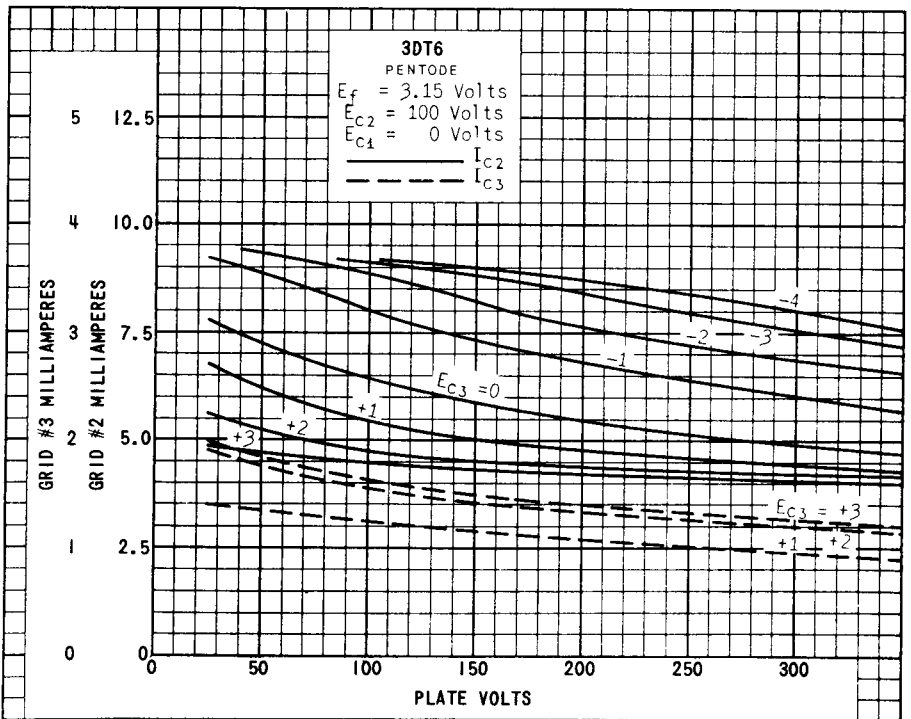
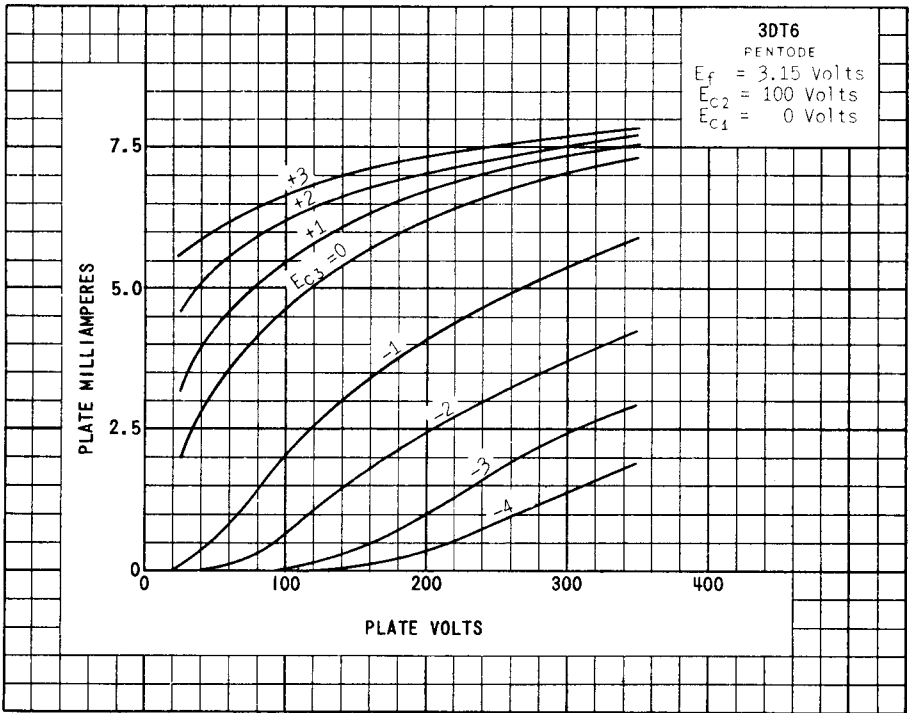

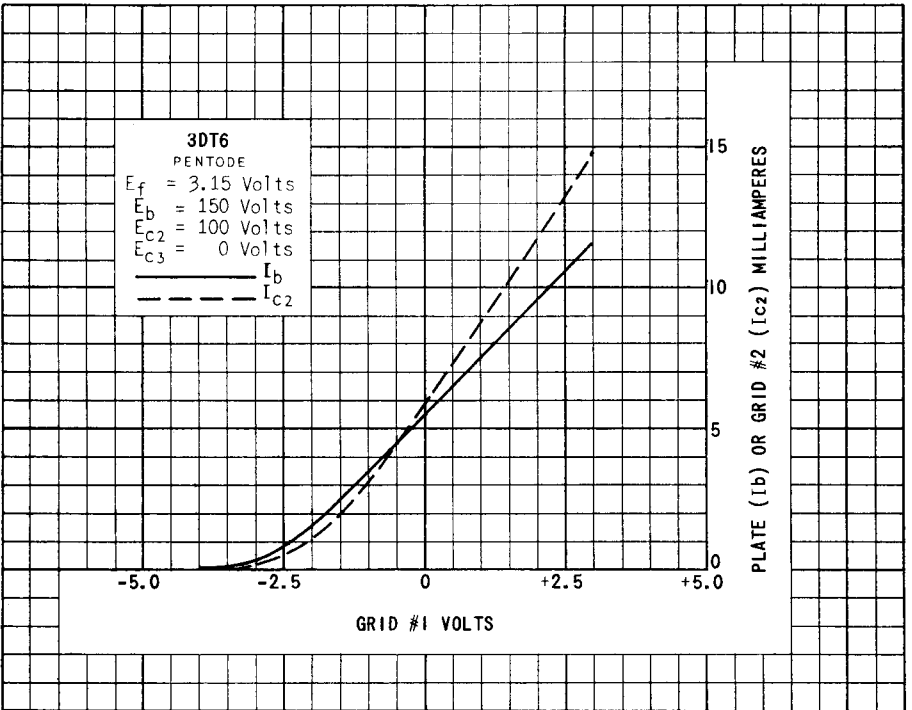
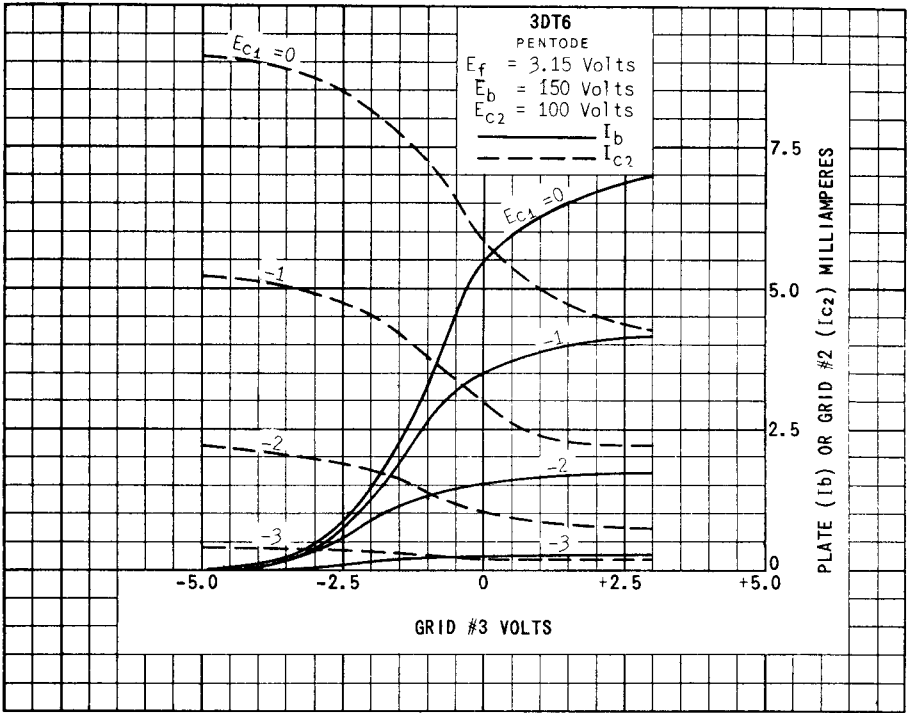

PRINTED IN U. S. A.