

## DISSIMILAR DOUBLE TRIODE

FOR TV VERTICAL-DEFLECTION OSCILLATOR AND AMPLIFIER APPLICATIONS

### DESCRIPTION AND RATING

The 6CY7 is a miniature tube which contains two dissimilar triodes in one envelope. The tube is intended for use as a combined vertical-deflection oscillator and amplifier in television receivers.

Except for heater ratings, the 8CY7 is identical to the 6CY7. In addition, the 8CY7 incorporates a controlled heater warm-up characteristic which makes it especially suited for use in television receivers that employ series-connected heaters.

#### GENERAL

##### ELECTRICAL

	6CY7	8CY7	
Cathode—Coated Unipotential			
Heater Voltage, AC or DC	6.3 ± 10%	7.9	Volts
Heater Current	0.75	0.6 ± 6%	Amperes
Heater Warm-up Time*		11	Seconds

Direct Interelectrode Capacitances, approximate†

	Section 1	Section 2	
Grid to Plate	1.8	4.4	μμf
Input	1.5	5.0	μμf
Output	0.30	1.0	μμf

##### MECHANICAL

Mounting Position—Any  
Envelope—T-6½, Glass  
Base—E9-1, Small Button 9-Pin

#### BASING DIAGRAM

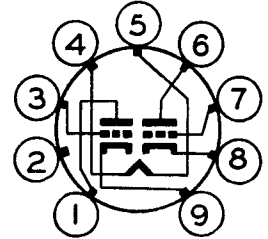

RETMA 9EF

#### TERMINAL CONNECTIONS

- Pin 1—Plate (Section 2)
- Pin 2—Internal Connection—  
Do not use
- Pin 3—Grid (Section 2)
- Pin 4—Heater
- Pin 5—Heater
- Pin 6—Plate (Section 1)
- Pin 7—Grid (Section 1)
- Pin 8—Cathode (Section 1)
- Pin 9—Cathode (Section 2)

#### PHYSICAL DIMENSIONS

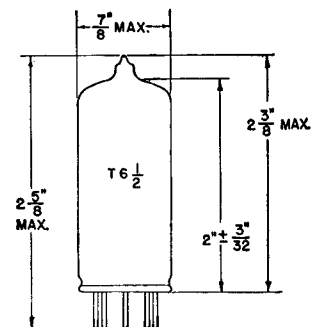

RETMA 6-3

## MAXIMUM RATINGS

	Vertical- Oscillator Service† (Section 1)	Vertical- Deflection Amplifier‡ (Section 2)	
<b>DESIGN-MAXIMUM VALUES</b>			
DC Plate Voltage . . . . .	350	350	Volts
Peak Positive Pulse Plate Voltage . . . . .	—	1800	Volts
Peak Negative Grid Voltage . . . . .	400	250	Volts
Plate Dissipation . . . . .	1.0	5.5§	Watts
DC Cathode Current . . . . .	—	35	Milliamperes
Peak Cathode Current . . . . .	—	120	Milliamperes
Heater-Cathode Voltage			
Heater Positive with Respect to Cathode			
DC Component . . . . .	100	100	Volts
Total DC and Peak . . . . .	200	200	Volts
Heater Negative with Respect to Cathode			
Total DC and Peak . . . . .	200	200	Volts
Grid Circuit Resistance			
With Fixed Bias . . . . .	2.2	—	Megohms
With Cathode Bias . . . . .	2.2	2.2	Megohms

Design-Maximum Ratings are the limiting values expressed with respect to bogie tubes at which satisfactory tube life can be expected to occur for the types of service for which the tube is rated. Therefore, the equipment designer must establish the circuit design so that initially and throughout equipment life no design-maximum value is exceeded with a bogie tube under the worst probable operating conditions with respect to supply-voltage variation, equipment component variation, equipment control adjustment, load variation, and environmental conditions.

## CHARACTERISTICS AND TYPICAL OPERATION

	Section 1 (Oscillator)	Section 2 (Amplifier)	
<b>AVERAGE CHARACTERISTICS</b>			
Plate Voltage . . . . .	250	60 150	Volts
Grid Voltage . . . . .	-3.0	0 —	Volts
Cathode-Bias Resistor . . . . .	—	— 620	Ohms
Amplification Factor . . . . .	68	— 5.0	
Plate Resistance, approximate . . . . .	52000	— 920	Ohms
Transconductance . . . . .	1300	— 5400	Micromhos
Plate Current . . . . .	1.2	80 30	Milliamperes
Plate Current, approximate			
$E_c = -30$ Volts . . . . .	—	— 3.5	Milliamperes
Grid Voltage, approximate			
$I_b = 200$ Microamperes . . . . .	—	— -40	Volts
Grid Voltage, approximate			
$I_b = 10$ Microamperes . . . . .	-5.5	— —	Volts

\* The time required for the voltage across the heater to reach 80 percent of its rated value after applying 4 times rated heater voltage to a circuit consisting of the tube heater in series with a resistance equal to 3 times the rated heater voltage divided by the rated heater current.

† Without external shield.

‡ For operation in a 525-line, 30-frame television system as described in "Standards of Good Engineering Practice Concerning Television Broadcast Stations," Federal Communications Commission. The duty cycle of the voltage pulse must not exceed 15 percent of one scanning cycle.

§ In stages operating with grid-leak bias, an adequate cathode-bias resistor or other suitable means is required to protect the tube in the absence of excitation.

**AVERAGE PLATE CHARACTERISTICS**

SECTION 1

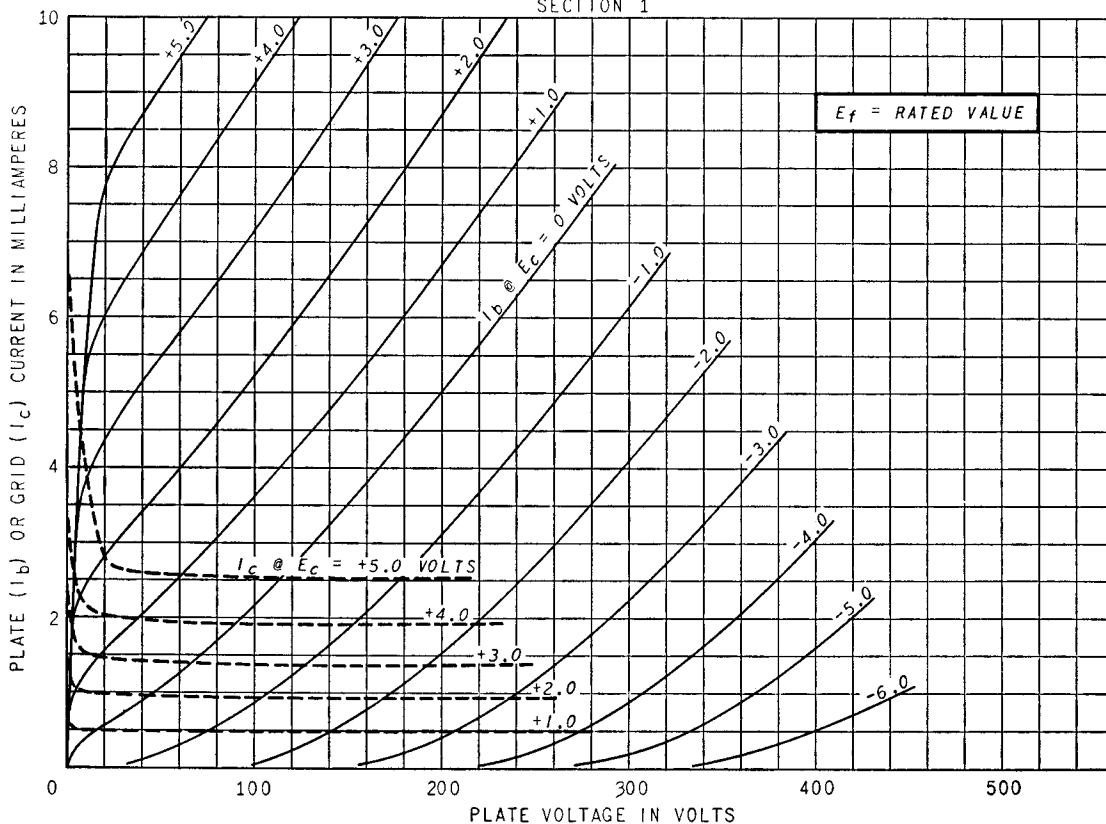

**AVERAGE PLATE CHARACTERISTICS**

SECTION 2

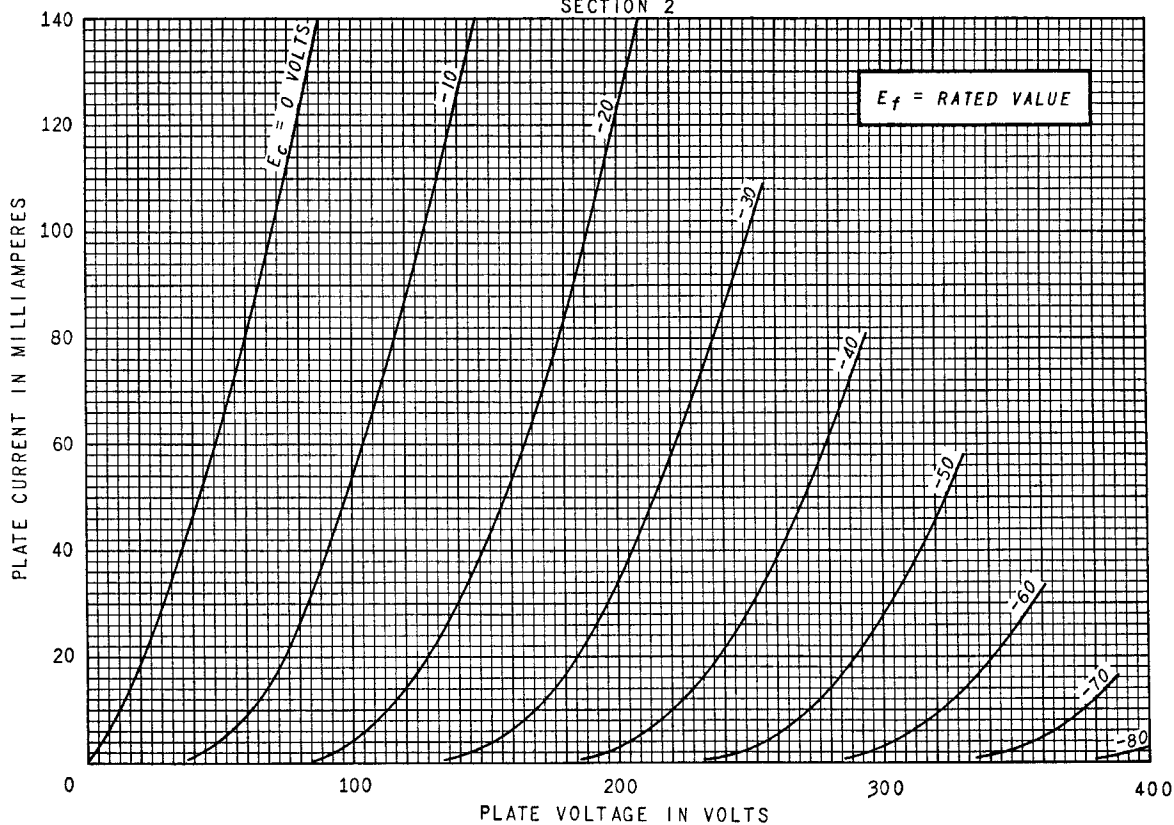

**AVERAGE CHARACTERISTICS**

SECTION 1

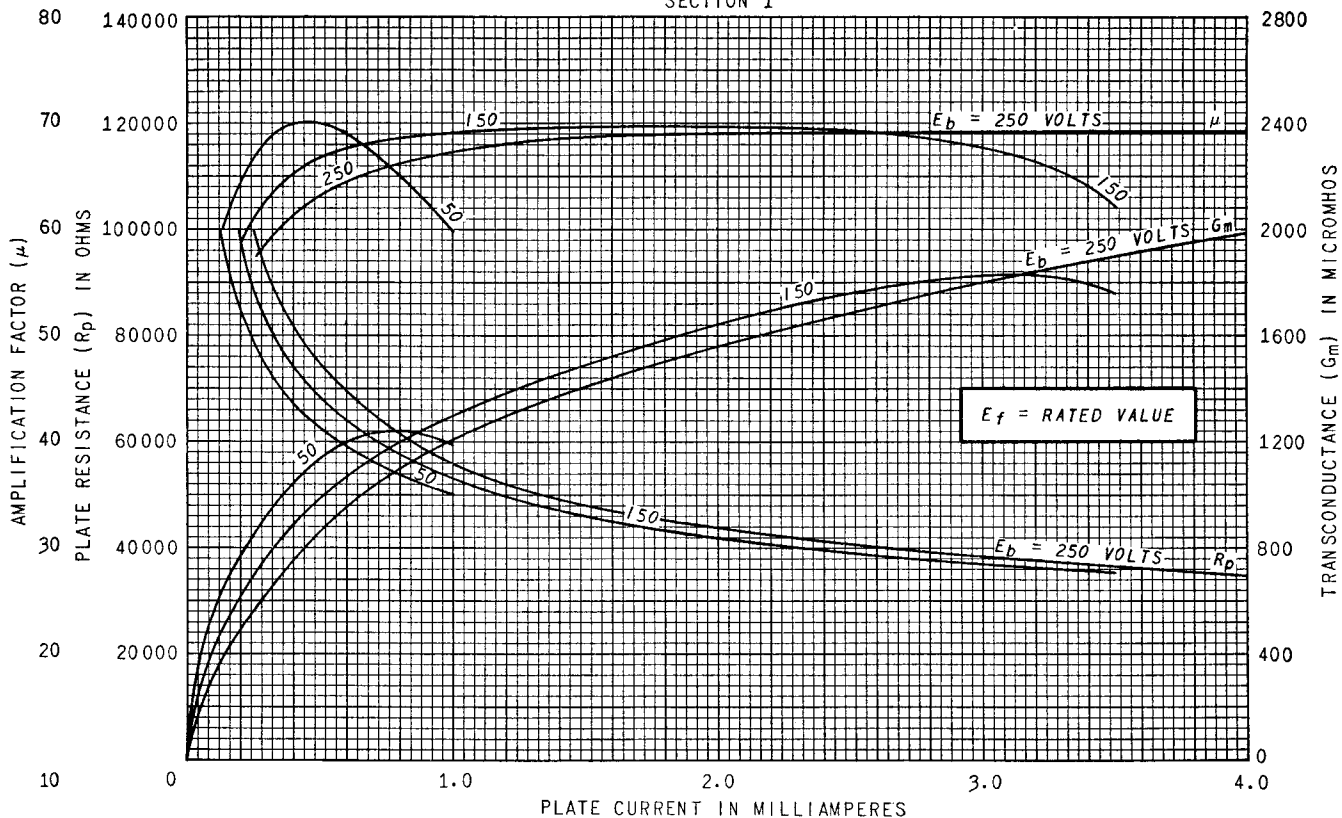

**AVERAGE CHARACTERISTICS**

SECTION 2

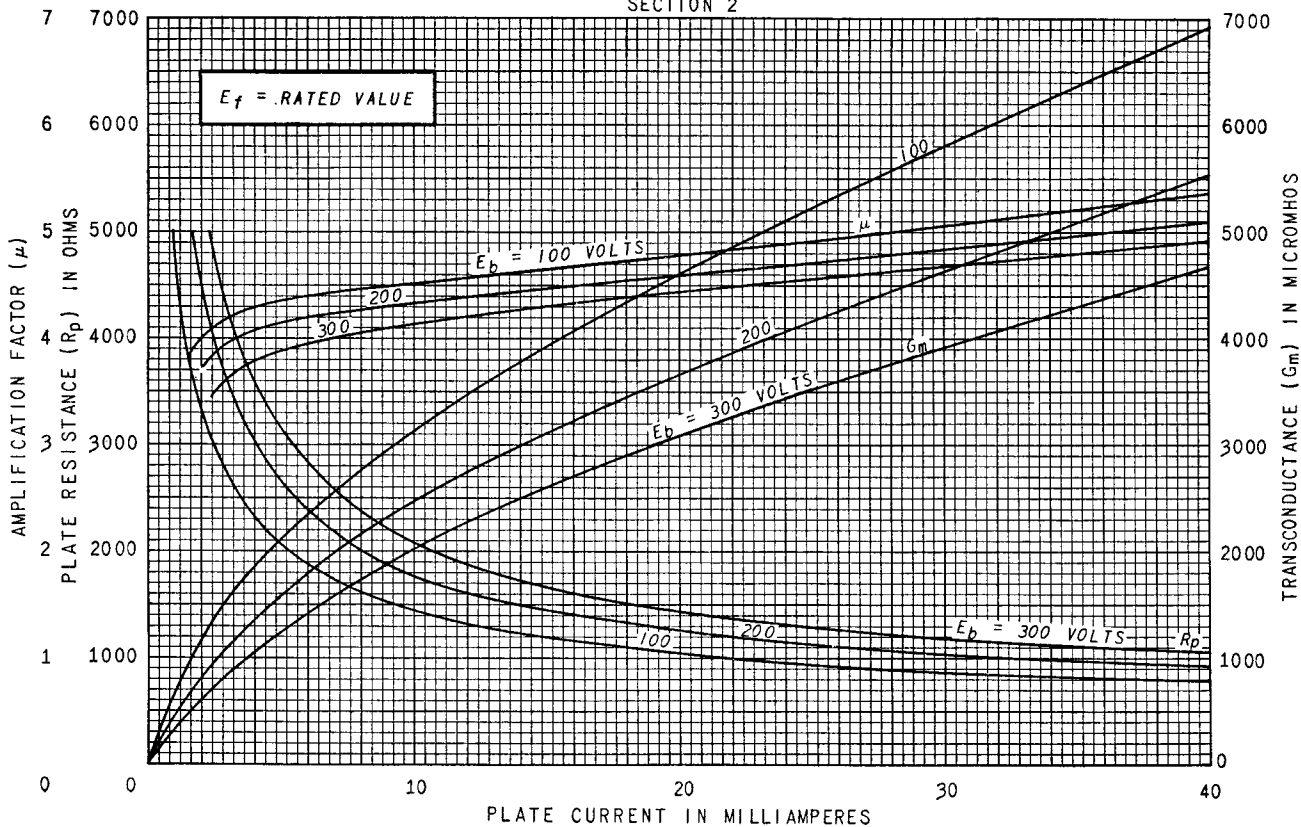

### AVERAGE TRANSFER CHARACTERISTICS

#### SECTION 1

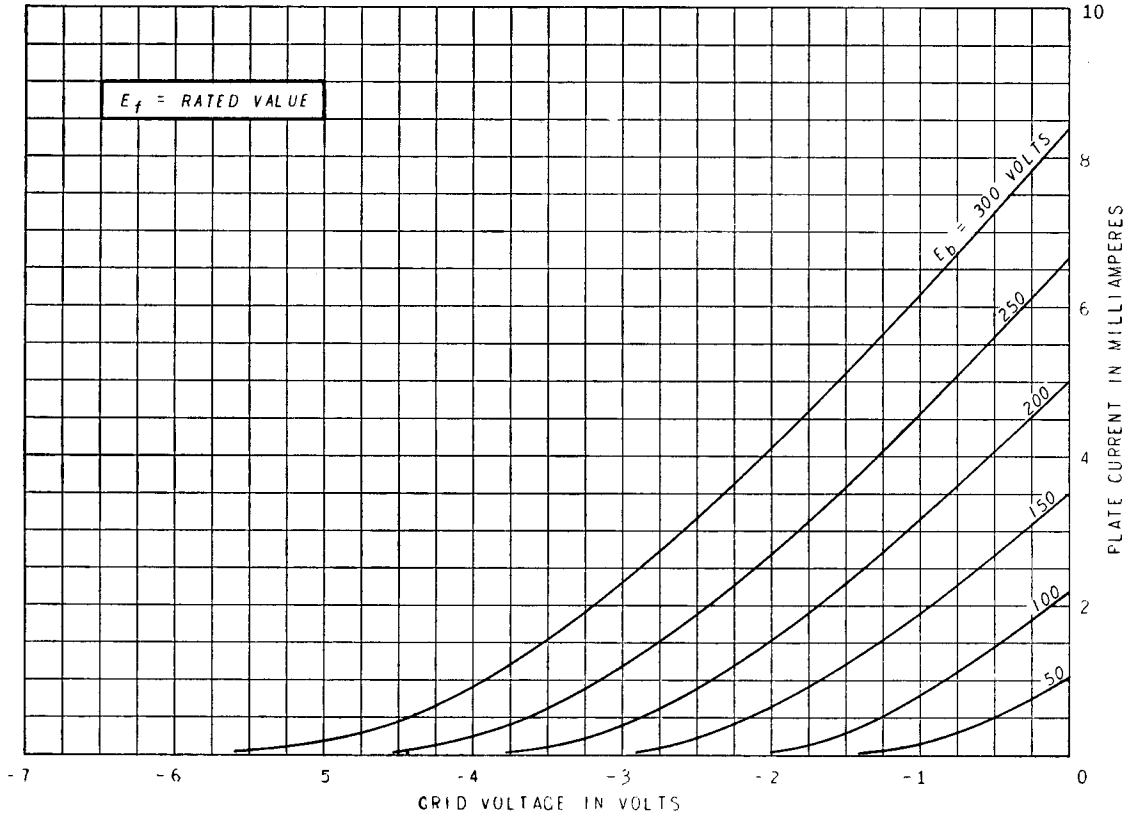

### AVERAGE TRANSFER CHARACTERISTICS

#### SECTION 2

