



7213

BEAM POWER TUBE

Ceramic-Metal Seals
 Matrix-Type Oxide-Coated
 Unipotential Cathode
 Coaxial-Electrode Structure

Full Ratings Up To 1215 Mc
 2500 Watts CW Input
 Forced-Air Cooled

TENTATIVE DATA

3-1/4" Length
 3-3/4" Diameter
 Unitized-Electrode Design
 Integral Radiator

RCA-7213 is a small, forced-air-cooled beam power tube designed for use as a linear rf power amplifier and as a class C rf power amplifier in airborne and fixed-station equipment. The 7213

electrode design combines each electrode, its support, and its gold-plated external contact surface. This type of construction facilitates accurate assembly of the electrodes and provides low-inductance, high-conductivity paths to the electrodes themselves. The respective electrode contact surfaces are insulated from each other by low-loss ceramic bushings. Another structural feature of the 7213 is its unipotential cathode of the oxide-coated matrix type for stability and long life, and its associated sturdy heater.



The coaxial structure with its ring-type ceramic-metal seals having graduated diameters makes the 7213 particularly useful in either coaxial-cylinder cavity or parallel-line circuits. Its small size for its power capability facilitates the construction of compact equipment utilizing grid-drive or cathode-drive circuits.

can be used with full ratings at frequencies up through the Aeronautical Radio-Navigation Band of 960 to 1215 Mc. It has a maximum plate-dissipation rating of 1500 watts.

When used under CCS conditions as an rf power amplifier and oscillator in class C telegraphy service, the 7213 has a maximum plate-voltage rating of 2500 volts and a maximum plate-input rating of 2500 watts. Under these conditions in a grid-drive circuit, the 7213 is capable of delivering useful power output of 1350 watts with a power gain of 20 at 600 Mc.

As a linear rf power amplifier in class AB₁ single-sideband suppressed-carrier service, the 7213 is capable of providing a maximum-signal power output (CCS) of 1250 watts.

Featured in the design of the 7213 is a coaxial-electrode structure in which unitized-

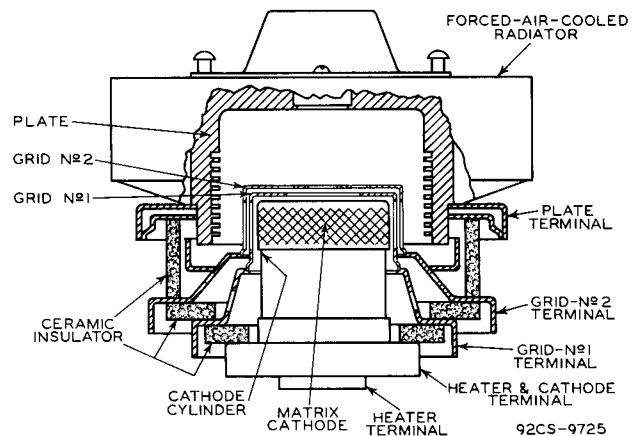

Fig. 1 - Structural Arrangement of Type 7213.

GENERAL DATA

Electrical:

Heater, for Matrix-Type Oxide-Coated Unipotential Cathode:	
Voltage (AC or DC)	{ 5.5 typical volts 6.0 max. volts
Current at 5.5 volts	17.5 amp
Minimum heating time at 5.5 volts	5 minutes



Mu-Factor, Grid No.2 to Grid No.1 for plate volts = 2500, grid-No.2 volts = 600, and plate ma = 600	17	
Direct Interelectrode Capacitances:		
Grid No.1 to plate*	0.17 max.	$\mu\mu\text{f}$
Grid No.1 to cathode.	42	$\mu\mu\text{f}$
Plate to cathode & heater*,**	0.014 max.	$\mu\mu\text{f}$
Grid No.1 to grid No.2.	55	$\mu\mu\text{f}$
Grid No.2 to plate.	16	$\mu\mu\text{f}$
Grid No.2 to cathode & heater**	1.4 max.	$\mu\mu\text{f}$

Mechanical:

Operating Position.	Any
Overall Length.	3.24" \pm 0.10"
Greatest Diameter (See <i>Dimensional Outline</i>).	3.70" \pm 0.05"
Terminal Connections.	See <i>Dimensional Outline</i>
Radiator.	Integral part of tube

Air Flow:
Through radiator--Adequate air flow to limit the plate-seal temperature to 250° C should be delivered by a blower through the radiator before and during the application of heater, plate, grid-No.2, and grid-No.1 voltages. Typical values of air flow directed through the radiator versus percentage of maximum rated plate dissipation for each class of service are shown in Fig.2. Plate power, grid-No.2 power, heater power, and air flow may be removed simultaneously.

To Grid-No.2, Grid-No.1, Cathode, and Heater Seals--A sufficient quantity of air should be directed at the heater terminal and allowed to flow past each of these seals so that its temperature does not exceed the specified maximum value of 250° C. An air flow of 10 cfm is usually adequate.

Seal Temperature (Plate, Grid No.2, Grid No.1, Cathode, and Heater)	250 max.	°C
Weight (Approx.).	2	lbs

**LINEAR RF POWER AMPLIFIER
Single-Sideband Suppressed-Carrier Service**

Maximum CCS[®] Ratings, Absolute Values:
Up to 1215 Mc

DC PLATE VOLTAGE	2500 max.	volts
DC GRID-No.2 (SCREEN) VOLTAGE.	1000 max.	volts
MAX.-SIGNAL DC PLATE CURRENT	1.0 max.	amp
MAX.-SIGNAL DC GRID-No.1 (CONTROL-GRID) CURRENT	0.2 max.	amp
MAX.-SIGNAL PLATE INPUT.	2500 max.	watts
MAX.-SIGNAL GRID-No.2 INPUT.	50 max.	watts
PLATE DISSIPATION.	1500 max.	watts

Typical CCS Class AB₁ "Single-Tone" Operation: $\bullet\bullet$

	Up to 60 Mc	
DC Plate voltage	2250	2500 volts
DC Grid-No.2 Voltage [▲]	700	700 volts
DC Grid-No.1 Voltage	-50	-50 volts
Zero-Signal DC Plate Current	0.2	0.2 amp
Zero-Signal DC Grid-No.2 Current	0	0 amp
Effective RF Load Resistance	1100	1100 ohms
Max.-Signal DC Plate Current	0.9	1.0 amp
Max.-Signal DC Grid-No.2 Current	0.45	0.45 amp
Max.-Signal DC Grid-No.1 Current	0	0 amp
Max.-Signal Peak RF Grid-No.1 Voltage.	50	50 volts
Max.-Signal Driving Power (Approx.)	0	0 watts
Max.-Signal Power Output (Approx.)	1000	1250 watts

PLATE-MODULATED RF POWER AMP.--Class C Telephony

Carrier conditions per tube for use with max. modulation factor of 1.0

Maximum CCS[®] Ratings, Absolute Values:
Up to 1215 Mc

DC PLATE VOLTAGE	2000 max.	volts
DC GRID-No.2 (SCREEN) VOLTAGE.	1000 max.	volts
DC GRID-No.1 (CONTROL- GRID) VOLTAGE.	-300 max.	volts

DC PLATE CURRENT	0.85 max.	amp
DC GRID-No.1 CURRENT	0.2 max.	amp
PLATE INPUT.	1700 max.	watts
GRID-No.2 INPUT.	35 max.	watts
PLATE DISSIPATION.	1000 max.	watts

Typical CCS Operation in Grid-Drive Circuit at 600 Mc:

DC Plate Voltage	1800	2000	volts
DC Grid-No.2 Voltage ^{●●}	500	500	volts
DC Grid-No.1 Voltage [★]	-30	-30	volts
DC Plate Current	0.75	0.83	amp
DC Grid-No.2 Current	0.015	0.015	amp
DC Grid-No.1 Current (Approx.)	0.04	0.04	amp
Driver Power Output (Approx.) [■]	50	55	watts
Useful Power Output (Approx.)	650†	800†	watts

Maximum Circuit Values:

Grid-No.1-Circuit Resistance: Under any condition.	5000† max.	ohms
---	------------	------

**RF POWER AMPLIFIER & OSC.--Class C Telephony[□]
and
RF POWER AMPLIFIER--Class C FM Telephony**

Maximum CCS[®] Ratings, Absolute Values:

	Up to 1215 Mc	
DC PLATE VOLTAGE	2500 max.	volts
DC GRID-No.2 (SCREEN) VOLTAGE.	1000 max.	volts
DC GRID-No.1 (CONTROL- GRID) VOLTAGE.	-300 max.	volts
DC PLATE CURRENT	1.0 max.	amp
DC GRID-No.1 CURRENT	0.2 max.	amp
PLATE INPUT.	2500 max.	watts
GRID-No.2 INPUT.	50 max.	watts
PLATE DISSIPATION.	1500 max.	watts

Typical CCS Operation in Grid-Drive Circuit at 600 Mc:

DC Plate Voltage	2250	2500	volts
DC Grid-No.2 Voltage [▴]	500	500	volts
DC GRID-No.1 Voltage [▴]	-30	-30	volts
DC Plate Current	0.9	1.0	amp
DC Grid-No.2 Current	0.02	0.02	amp
DC Grid-No.1 Current (Approx.)	0.07	0.07	amp
Driver Power Output (Approx.) [■]	70	75	watts
Useful Power Output (Approx.)	1050†	1350†	watts

Maximum Circuit Values:

Grid-No.1-Circuit Resistance: Under any condition.	5000† max.	ohms
---	------------	------

SPECIAL PERFORMANCE DATA

Design samples of the 7213 have been subjected to the following tests without adverse effects.

Variable-Frequency Vibration Performance:

This test was performed (per MIL-E-16[○], par.4.9.20.3) under the following conditions: Heater voltage of 5.5 volts, plate supply voltage of 450 volts, grid-No.2 voltage of 300 volts, grid-No.1 voltage varied to give a plate current of 10 milliamperes, and plate load resistor of 2000 ohms. The tubes were vibrated in each of 3 positions through frequency range from 10 to 50 to 10 cycles per second. The vibrating frequency had a fixed amplitude of 0.040 inch (total excursion of 0.080 inch). During the test, the tubes did not show an rms output voltage across the plate load resistor in excess of 250 millivolts.

At the end of this test, the tubes did not show tap or permanent interelectrode shorts or defects that would cause the tubes to be inoperable. The tubes exhibited no pronounced mechanical resonance during this test.

[○] Military Specification, Electron Tubes and Crystal Rectifiers, 3 October 1955.



Fatigue Performance:

In this test (per MIL-E-1C, par.4.9.20.6), the tubes were rigidly mounted and subjected to 2.5g vibrational acceleration at 25 cycles per second for 32 hours in each of three positions with 5.5 volts applied to the heater. At the end of this test, the tubes did not show permanent or temporary shorts or open circuits, and passed all electrical tests.

- ♣ Because the cathode is subjected to considerable back bombardment as the frequency is increased with resultant increase in temperature, the heater voltage should be reduced depending on operating conditions and frequency to prevent overheating the cathode and resultant short life.
- * With external flat metal shield having diameter of 8", and center hole approximately 3" in diameter provided with spring fingers that connect the shield to grid-No.2 terminal. Shield is located in plane of grid-No.2 terminal perpendicular to the tube axis.
- ** With external flat metal shield having diameter of 8", and center hole approximately 2-3/8" in diameter provided with spring fingers that connect the shield to grid-No.1 terminal. Shield is located in plane of grid-No.1 terminal perpendicular to the tube axis.
- Continuous Commercial Service.
- ♣♣ "Single-Tone" operation refers to that class of amplifier service in which the grid-No.1 input consists of a monofrequency rf signal having constant amplitude. This signal is produced in a single-sideband suppressed-carrier system when a single audio frequency of constant amplitude is applied to the input of the system.
- ▲ Preferably obtained from a fixed supply.
- Obtained preferably from a separate source modulated along with the plate supply.
- ★ Obtained from grid-No.1 resistor or from a combination of grid-No.1 resistor with either fixed supply or cathode resistor.
- The driver stage is required to supply tube losses and rf circuit losses. It should be designed to provide an excess of power above the indicated value to take care of variations in line voltage, in components, in initial tube characteristics, and in tube characteristics during life.
- † This value of useful power is measured in load of output circuit.
- ‡ If this value is insufficient to provide adequate bias, the additional required bias must be supplied by a cathode resistor or fixed supply.
- Key-down conditions per tube without amplitude modulation. Amplitude modulation essentially negative may be used if the positive peak of the audio-frequency envelope does not exceed 115% of the carrier conditions.
- ⊕ Obtained preferably from a fixed supply, or from the plate-supply voltage with a voltage divider.
- ⊕⊕ Obtained from fixed supply, by grid-No.1 resistor, by cathode resistor, or by combination methods.

OPERATING CONSIDERATIONS

The *maximum ratings* in the tabulated data are established in accordance with the following definition of the *Absolute-Maximum Rating System* for rating electron devices.

Absolute-Maximum ratings are limiting values of operating and environmental conditions applicable to any electron device of a specified type as defined by its published data, and should not be exceeded under the worst probable conditions.

The device manufacturer chooses these values to provide acceptable serviceability of the device, taking no responsibility for equipment variations, environment variations, and the effects of changes in operating conditions due to variations in device characteristics.

The equipment manufacturer should design so that initially and throughout life no absolute-maximum value for the intended service is exceeded with any device under the worst probable operating conditions with respect to supply-voltage

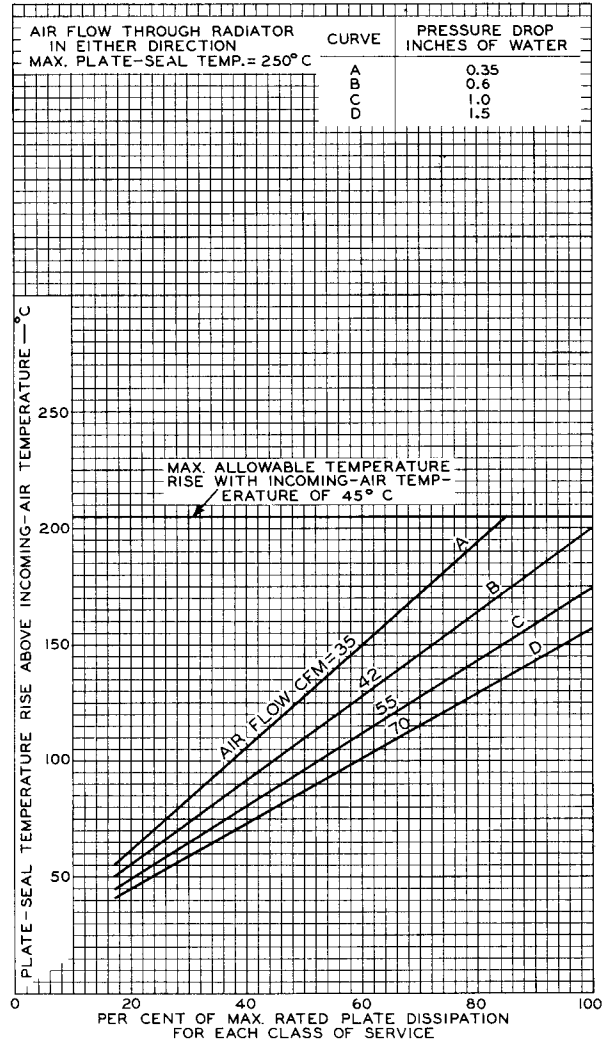

92CM-9737

Fig. 2 - Typical Cooling Requirements for Type 7213.

variation, equipment-component variation, equipment-control adjustment, load variation, signal variation, environmental conditions, and variations in device characteristics.

The *maximum seal temperature* of 250°C is a tube rating and is to be observed in the same manner as other ratings. The temperature may be measured with temperature-sensitive paint, such as Tempilaq. The latter is made by the Tempil Corporation, 132 W. 22nd Street, New York 11, New York in the form of liquid and stick.

The rated plate and grid-No.2 voltages of this tube are extremely dangerous to the user.



Great care should be taken during the adjustment of circuits. The tube and its associated apparatus, especially all parts which may be at high potential above ground, should be housed in a protective enclosure. The protective housing should be designed with interlocks so that personnel can not possibly come in contact with any

high-potential point in the electrical system. The interlock devices should function to break the primary circuit of the high-voltage supplies when any gate or door on the protective housing is opened, and should prevent the closing of the primary circuit until the door is again locked.

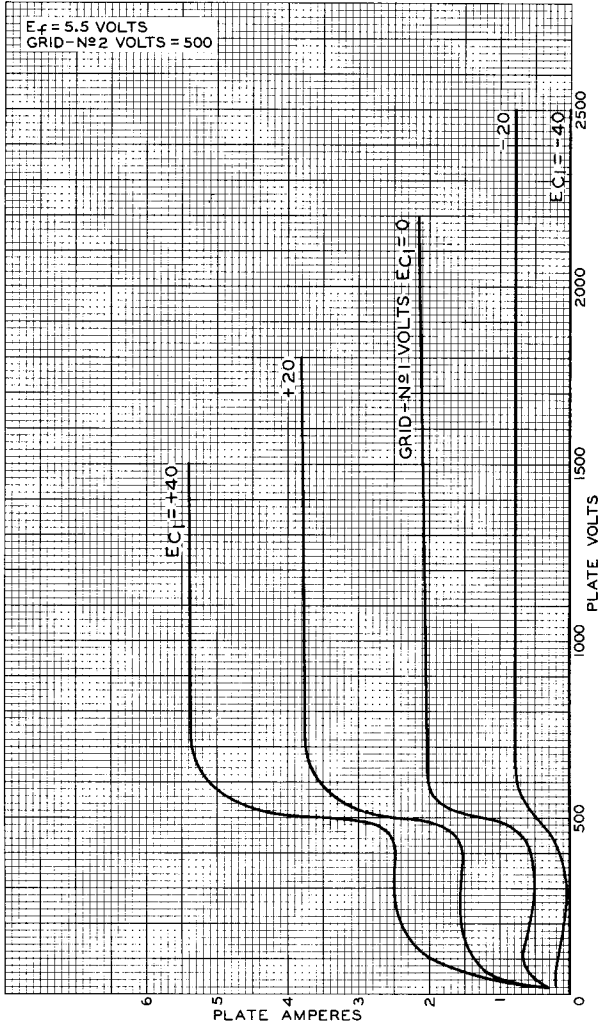

92CM-9738

Fig. 3 - Typical Plate Characteristics of Type 7213.

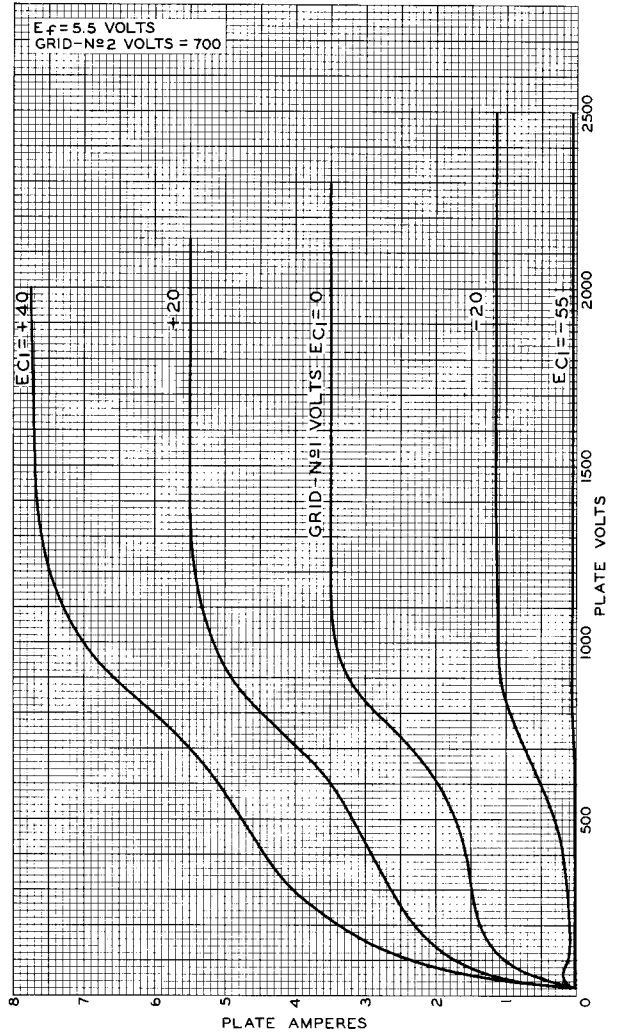

92CM-9753

Fig. 4 - Typical Plate Characteristics of Type 7213.

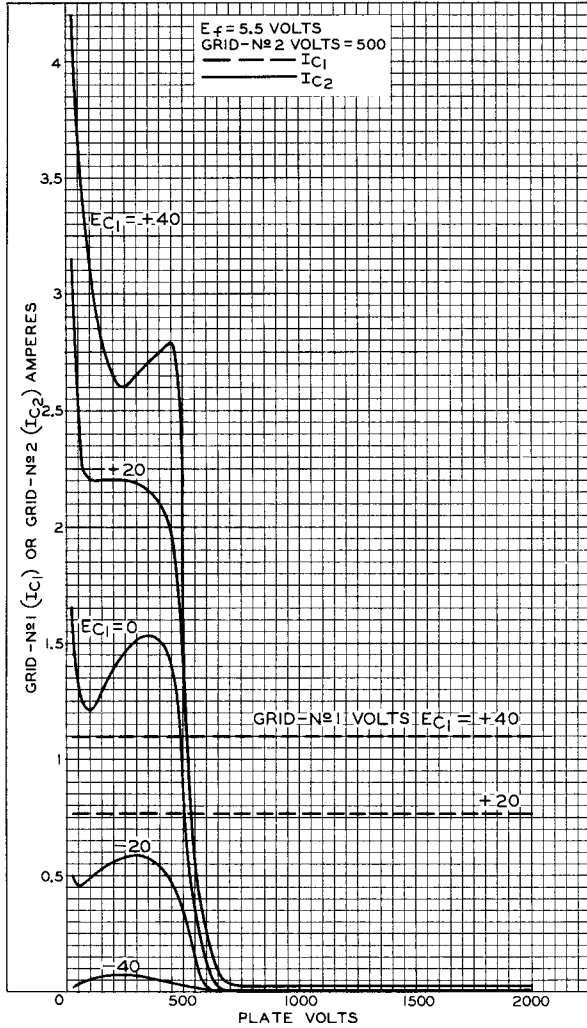

92CM-9740

Fig.5 - Typical Characteristics of Type 7213.

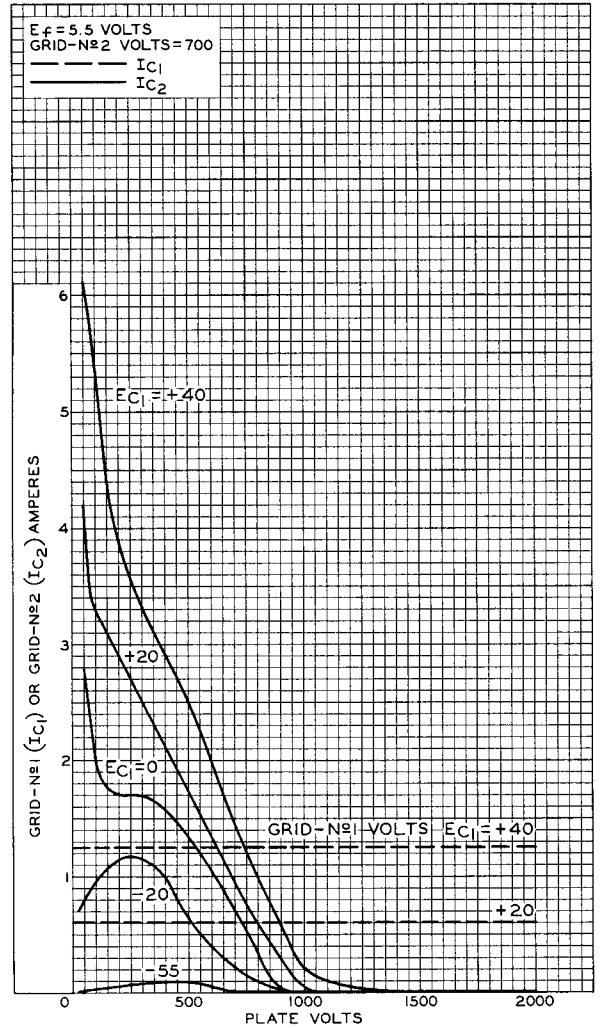

92CM-9754

Fig.6 - Typical Characteristics of Type 7213.

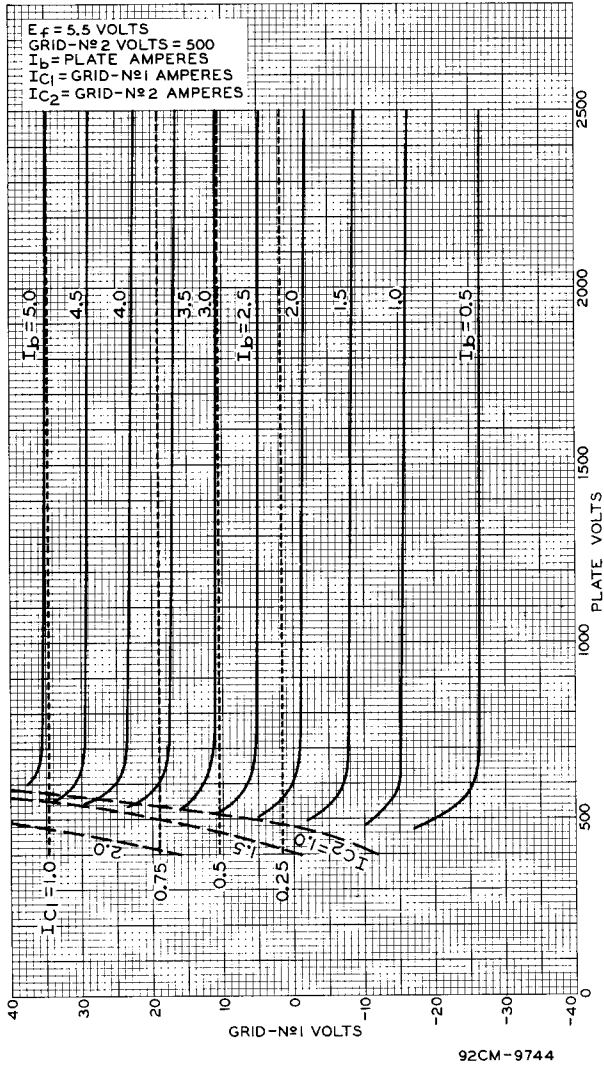

Fig. 7 - Typical Constant-Current Characteristics of Type 7213.

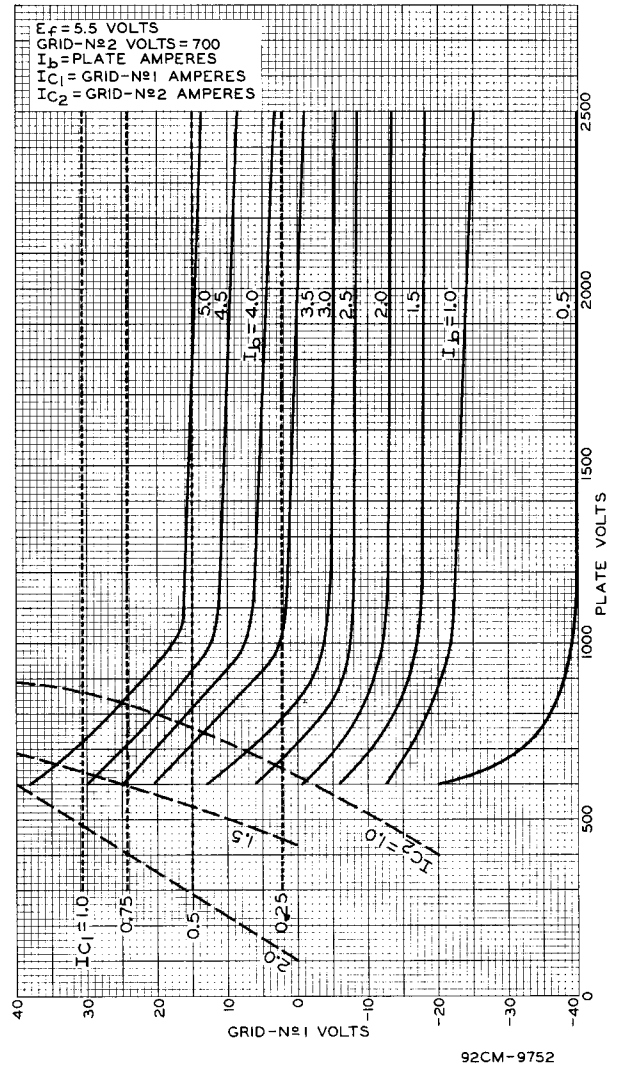

Fig. 8 - Typical Constant-Current Characteristics of Type 7213.

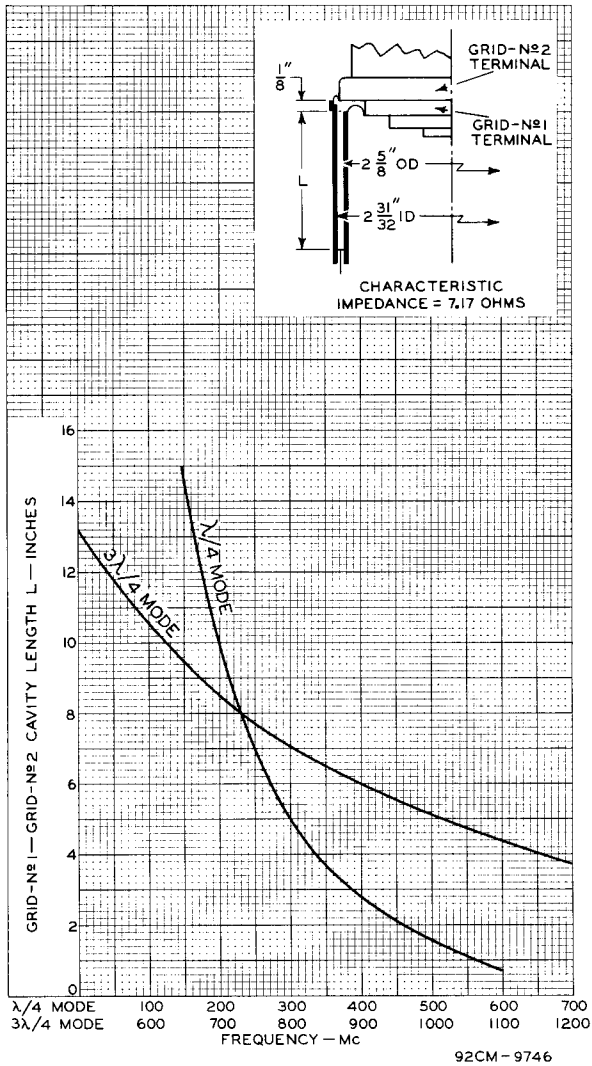

Fig. 9 - Grid No. 1--Grid No. 2 Tuning Curves.

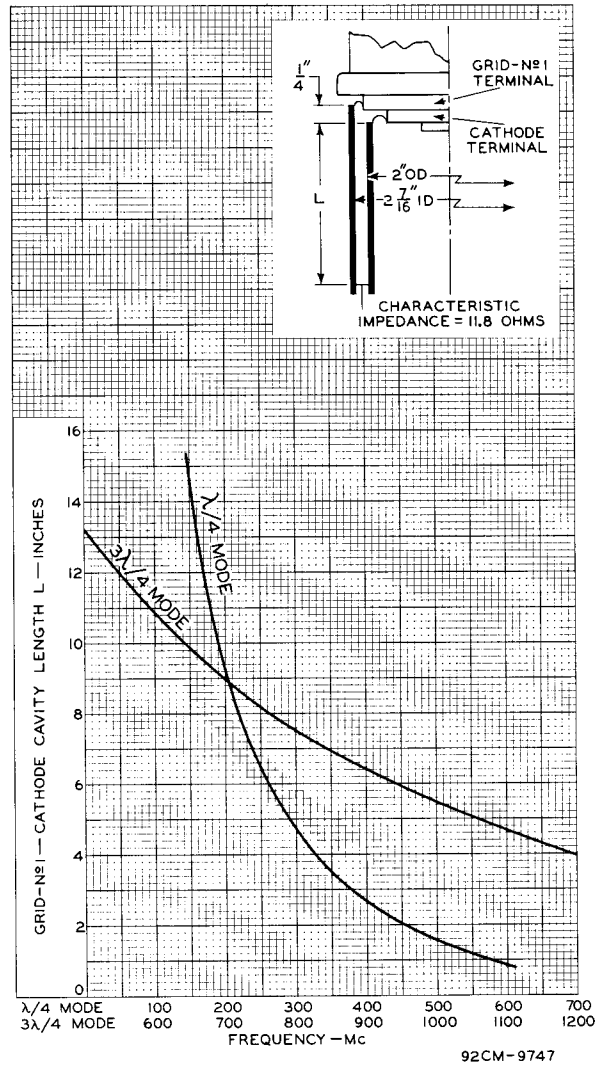
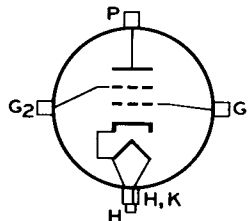

Fig. 10 - Grid No. 1--Cathode Tuning Curves.

TERMINAL CONNECTIONS

- G_1 = Grid-No.1 Terminal Contact Surface (Adjacent to Cathode & Heater Terminal contact Surface)
- G_2 = Grid-No.2 Terminal Contact Surface (Adjacent to Grid-No.1 Terminal Contact Surface)
- H = Heater Terminal Contact Surface (Cup at end opposite Air-cooled Radiator)



- H, K = Cathode & Heater Terminal Contact Surface (Adjacent to Heater Terminal Contact Surface)
- P = Plate Terminal Contact Surface (Adjacent to Air-cooled Radiator)

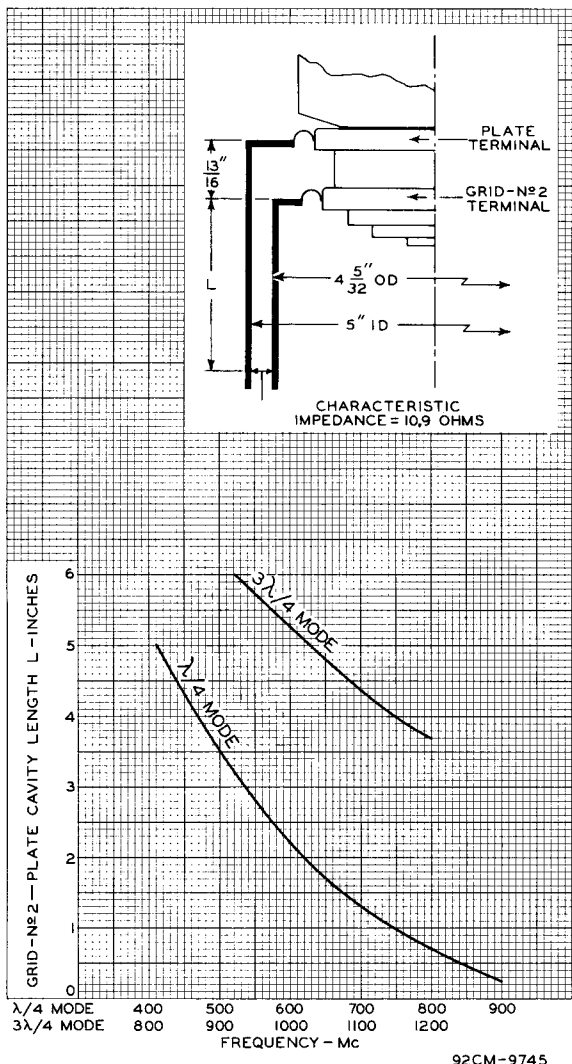

DIMENSIONAL OUTLINE

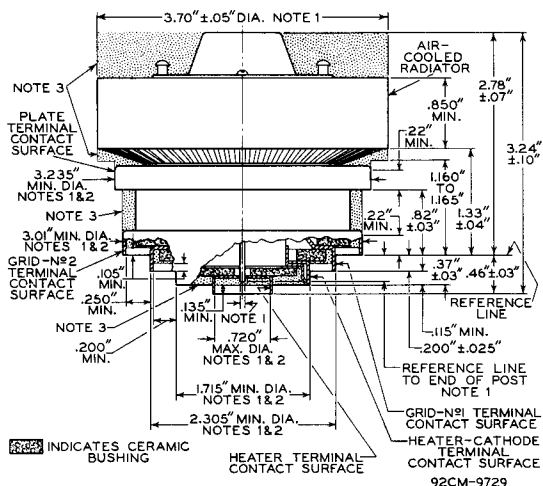

NOTE 1: WITH THE CYLINDRICAL SURFACES OF THE RADIATOR BAND, PLATE TERMINAL, HEATER-CATHODE TERMINAL, AND HEATER TERMINAL CLEAN, SMOOTH, AND FREE OF BURRS, THE TUBE WILL ENTER A GAUGE AS SHOWN IN SKETCH G₁. PROPER ENTRY OF THE TUBE IS OBTAINED WHEN THE GRID-NO. 2 TERMINAL IS SEATED ON THE SHOULDER A - A'. THE TUBE IS PROPERLY SEATED ON THE SHOULDER WHEN A 0.010" THICKNESS GAUGE 1/8" WIDE WILL NOT ENTER MORE THAN 1/16" BETWEEN THE SHOULDER SURFACE AND THE GRID-NO. 2 TERMINAL. THE GAUGE IS PROVIDED WITH SLOTS TO PERMIT MAKING MEASUREMENT OF SEATING OF GRID-NO. 2 TERMINAL ON SHOULDER A - A'.

NOTE 2: THE DIAMETER OF EACH TERMINAL IS HELD TO INDICATED VALUES ONLY OVER THE INDICATED MINIMUM LENGTH OF ITS CONTACT SURFACE.

NOTE 3: KEEP ALL STIPPLED REGIONS CLEAR. DO NOT ALLOW CONTACTS OR CIRCUIT COMPONENTS TO PROTRUDE INTO THESE ANNULAR VOLUMES.

GAUGE SKETCH G₁

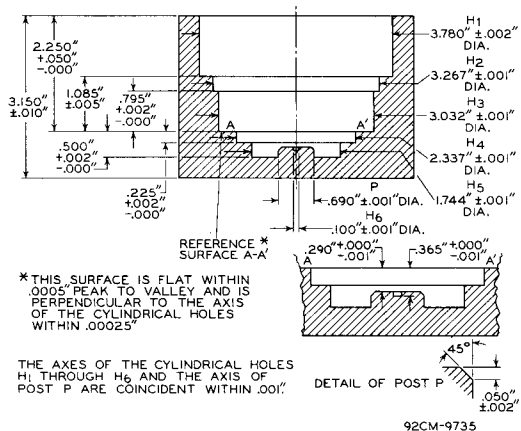
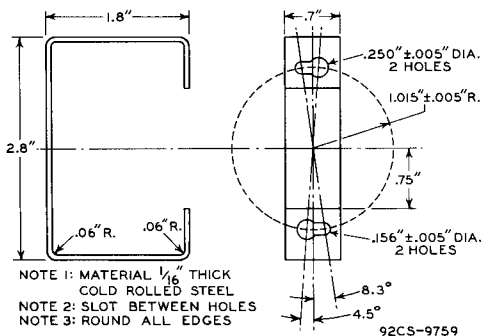

Fig. 11 - Grid No. 2--Plate Tuning Curves.

SUGGESTED DESIGN OF HANDLE FOR EXTRACTING 7213 FROM CAVITY



Devices and arrangements shown or described herein may use patents of RCA or others. Information contained herein is furnished without responsibility by RCA for its use and without prejudice to RCA's patent rights.