

## Beam Power Tube

COAXIAL-ELECTRODE STRUCTURE  
 CERAMIC-METAL SEALS  
 UNIPOTENTIAL CATHODE

FORCED-AIR COOLED  
 INTEGRAL RADIATOR  
 180 WATTS CW INPUT UP TO 1215 Mc

For Use at Frequencies up to 2000 Mc

### GENERAL DATA

#### Electrical:

Heater, for Unipotential Cathode:

Voltage (AC or DC) <sup>a</sup> . . . . .	6.3 ± 10%	volts
Current at heater volts = 6.3 . . . . .	2.1	amp
Minimum heating time. . . . .	60	sec

Mu-Factor, Grid No.2 to Grid No.1

for plate volts = 250, grid-No.2 volts = 250, and plate ma = 100 . . . . .	18
---	----

Direct Interelectrode Capacitances: <sup>b</sup>

Grid No.1 to plate. . . . .	0.065 max.	pf
Grid No.1 to cathode & heater . . . . .	14.0	pf
Plate to cathode & heater . . . . .	0.015 max.	pf
Grid No.1 to grid No.2. . . . .	17.0	pf
Grid No.2 to plate. . . . .	4.4	pf
Grid No.2 to cathode & heater . . . . .	0.4 max.	pf

#### Mechanical:

Operating Position. . . . .	Any
Overall Length. . . . .	1.88" ± 0.05" ←
Greatest Diameter . . . . .	1.250" ± 0.015"
Weight (Approx.). . . . .	2 oz
Radiator. . . . .	Integral part of tube

Socket:

For use up to about 400 Mc:

For socket to be used with the 6816 consult manufacturers such as J-V-M Microwave Company, 9300 W. 47th St., Brookfield, Ill., E. F. Johnson Company, Waseca, Minn.; Collins Radio Co., 855 35th St. N., Cedar Rapids, Iowa, and Jettron Products, Route 10, Hanover, N.J.

For use at higher frequencies:

See *Mounting Arrangement*.

Terminal Diagram (See *Dimensional Outline*):

- G<sub>1</sub> - Grid No.1 - Terminal Contact Surface
- G<sub>2</sub> - Grid No.2 - Terminal Contact Surface
- H - Heater - Terminal Contact Surface

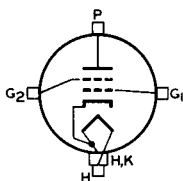

- H, K - Heater - & Cathode - Terminal Contact Surface
- P - Plate Terminal Contact Surface

← Indicates a change.



## Thermal:

Plate, Grid No.2, Grid No.1,

Cathode, and Heater Temperature<sup>v</sup>. . . . . 250 max. °C

Radiator Core Temperature<sup>v</sup>. . . . . 250 max. °C

Air Flow:

*Through radiator*—Adequate air flow to limit the radiator core temperature to 250° C should be delivered by a blower through the radiator before and during the application of plate, grid-No.2, and grid-No.1 voltages. Typical values of air flow directed through the radiator without cowling and with cowling versus plate dissipation are shown in the accompanying *Typical Cooling Requirements* curves. Plate power, grid-No.2 power, and air flow may be removed simultaneously.

*To grid-No.2, grid-No.1, cathode, and heater terminals*—A sufficient quantity of air should be delivered to these terminals to prevent their temperature from exceeding the specified maximum value of 250° C.

*During standby operation*—Cooling air is not normally required when only heater voltage is applied to the tube.

Terminal Temperature (Plate, Grid No.2,

Grid No.1, Cathode, and Heater) . . . . . 250 max. °C

## AF POWER AMPLIFIER & MODULATOR — Class AB<sub>1</sub><sup>c</sup>

### Maximum CCS<sup>d</sup> Ratings, Absolute-Maximum Values:

DC PLATE VOLTAGE. . . . .	1000 max.	volts
DC GRID-No.2 (SCREEN-GRID) VOLTAGE. . . . .	300 max.	volts
MAX.—SIGNAL DC PLATE CURRENT <sup>e</sup> . . . . .	180 max.	ma
MAX.—SIGNAL PLATE INPUT <sup>e</sup> . . . . .	180 max.	watts
MAX.—SIGNAL GRID-No.2 INPUT <sup>e</sup> . . . . .	4.5 max.	watts
PLATE DISSIPATION <sup>e</sup> . . . . .	115 max.	watts

### Typical CCS Operation:

*Values are for 2 tubes*

DC Plate Voltage. . . . .	650	850	volts
DC Grid-No.2 Voltage <sup>f</sup> . . . . .	300	300	volts
DC Grid-No.1 (Control-Grid) Voltage:			
From fixed-bias source. . . . .	-15	-15	volts
Peak AF Grid-No.1-to-Grid-No.1 Voltage <sup>g</sup> . . . . .	30	30	volts
Zero-Signal DC Plate Current. . . . .	80	80	ma
Max.—Signal DC Plate Current. . . . .	200	200	ma
Zero-Signal DC Grid-No.2 Current. . . . .	0	0	ma
Max.—Signal DC Grid-No.2 Current. . . . .	20	20	ma
Effective Load Resistance			
(Plate to plate). . . . .	4330	7000	ohms
Max.—Signal Driving Power (Approx.) . . . . .	0	0	watts
Max.—Signal Power Output (Approx.) . . . . .	50	80	watts

### Maximum Circuit Values:

Grid-No.1—Circuit Resistance under any condition:<sup>h</sup>

    For fixed-bias operation. . . . . 30000 max. ohms

    For cathode-bias operation. . . . . Not recommended



AF POWER AMPLIFIER & MODULATOR — Class AB<sub>2</sub><sup>j</sup>Maximum CCS<sup>d</sup> Ratings, Absolute-Maximum Values:

DC PLATE VOLTAGE. . . . .	1000 max.	volts
DC GRID-No.2 (SCREEN-GRID) VOLTAGE. . . . .	300 max.	volts
MAX.-SIGNAL DC PLATE CURRENT <sup>e</sup> . . . . .	180 max.	ma
MAX.-SIGNAL DC GRID-No.1 (CONTROL- GRID) CURRENT <sup>e</sup> . . . . .	30 max.	ma
MAX.-SIGNAL PLATE INPUT <sup>e</sup> . . . . .	180 max.	watts
MAX.-SIGNAL GRID-No.2 INPUT <sup>e</sup> . . . . .	4.5 max.	watts
PLATE DISSIPATION <sup>e</sup> . . . . .	115 max.	watts

## Typical CCS Operation:

Values are for 2 tubes

DC Plate Voltage. . . . .	650	850	volts
DC Grid-No.2 Voltage <sup>f</sup> . . . . .	300	300	volts
DC Grid-No.1 Voltage: From fixed-bias source. . . . .	-15	-15	volts
Peak AF Grid-No.1-to-Grid-No.1 Voltage. . . . .	46	46	volts
Zero-Signal DC Plate Current. . . . .	80	80	ma
Max.-Signal DC Plate Current. . . . .	355	355	ma
Zero-Signal DC Grid-No.2 Current. . . . .	0	0	ma
Max.-Signal DC Grid-No.2 Current. . . . .	25	25	ma
Max.-Signal DC Grid-No.1 Current. . . . .	15	15	ma
Effective Load Resistance (Plate to plate). . . . .	2450	3960	ohms
Max.-Signal Driving Power (Approx.) <sup>k</sup> . . . . .	0.3	0.3	watt
Max.-Signal Power Output (Approx.). . . . .	85	140	watts

## LINEAR RF POWER AMPLIFIER

## Single-Sideband Suppressed-Carrier Service

Maximum CCS<sup>d</sup> Ratings, Absolute-Maximum Values:

Up to 1215 Mc

DC PLATE VOLTAGE. . . . .	1000 max.	volts
DC GRID-No.2 (SCREEN-GRID) VOLTAGE. . . . .	300 max.	volts
MAX.-SIGNAL DC PLATE CURRENT. . . . .	180 max.	ma
MAX.-SIGNAL DC GRID-No.1 (CONTROL- GRID) CURRENT. . . . .	30 max.	ma
MAX.-SIGNAL PLATE INPUT. . . . .	180 max.	watts
MAX.-SIGNAL GRID-No.2 INPUT. . . . .	4.5 max.	watts
PLATE DISSIPATION. . . . .	115 max.	watts

Typical CCS Class AB<sub>1</sub> "Single-Tone" Operation:<sup>m</sup>

Up to 60 Mc

DC Plate Voltage. . . . .	650	850	volts
DC Grid-No.2 Voltage <sup>f</sup> . . . . .	300	300	volts
DC Grid-No.1 Voltage. . . . .	-15	-15	volts
Zero-Signal DC Plate Current. . . . .	40	40	ma
Zero-Signal DC Grid-No.2 Current. . . . .	0	0	ma
Effective RF Load Resistance. . . . .	2165	3500	ohms
Max.-Signal DC Plate Current. . . . .	100	100	ma
Max.-Signal DC Grid-No.2 Current. . . . .	10	10	ma
Max.-Signal DC Grid-No.1 Current. . . . .	0	0	ma



Max.-Signal Peak RF Grid-No.1 Voltage . . .	15	15	volts
Max.-Signal Driving Power (Approx.) . . . .	0	0	watts
Max.-Signal Power Output (Approx.) . . . .	25	40	watts

**Maximum Circuit Values:**

Grid-No.1-Circuit Resistance under any condition:

For fixed-bias operation . . . . .	30000	ohms
For cathode-bias operation . . . . .	Not recommended	

**PLATE-MODULATED RF POWER AMPLIFIER — Class C Telephony**

*Carrier conditions per tube for use  
with a maximum modulation factor of 1*

**Maximum CCS<sup>d</sup> Ratings, Absolute-Maximum Values:**

	<i>Up to 1215 Mc</i>	
DC PLATE VOLTAGE . . . . .	800 max.	volts
DC GRID-No.2 (SCREEN-GRID) VOLTAGE . . . . .	300 max.	volts
DC GRID-No.1 (CONTROL-GRID) VOLTAGE . . . . .	-100 max.	volts
DC PLATE CURRENT . . . . .	150 max.	ma
DC GRID-No.1 CURRENT . . . . .	30 max.	ma
PLATE INPUT . . . . .	120 max.	watts
GRID-No.2 INPUT . . . . .	3 max.	watts
PLATE DISSIPATION . . . . .	75 max.	watts

**Typical CCS Operation:**

	<i>At 400 Mc</i>		
DC Plate Voltage . . . . .	400	700	volts
DC Grid-No.2 Voltage <sup>n</sup> . . . . .	200	250	volts
DC Grid-No.1 Voltage <sup>p</sup> . . . . .	-20	-50	volts
DC Plate Current . . . . .	100	130	ma
DC Grid-No.2 Current . . . . .	5	10	ma
DC Grid-No.1 Current . . . . .	5	10	ma
Driver Power Output (Approx.) <sup>q</sup> . . . . .	2	3	watts
Useful Power Output (Approx.) . . . . .	16	45	watts

**Maximum Circuit Values:**

Grid-No.1-Circuit Resistance  
under any condition . . . . . 30000<sup>r</sup> max. ohms

**RF POWER AMPLIFIER & OSCILLATOR — Class C Telegraphy<sup>s</sup>  
and  
RF POWER AMPLIFIER — Class C FM Telephony**

**Maximum CCS<sup>d</sup> Ratings, Absolute-Maximum Values:**

	<i>Up to 1215 Mc</i>	
DC PLATE VOLTAGE . . . . .	1000 max.	volts
DC GRID-No.2 (SCREEN-GRID) VOLTAGE . . . . .	300 max.	volts
DC GRID-No.1 (CONTROL-GRID) VOLTAGE . . . . .	-100 max.	volts
DC PLATE CURRENT . . . . .	180 max.	ma
DC GRID-No.1 CURRENT . . . . .	30 max.	ma
PLATE INPUT . . . . .	180 max.	watts
GRID-No.2 INPUT . . . . .	4.5 max.	watts
PLATE DISSIPATION . . . . .	115 max.	watts



## Typical CCS Operation:

	At 400 Mc		At 1215 Mc	
DC Plate Voltage. . . . .	400	900	900	volts
DC Grid-No.2 Voltage <sup>t</sup> . . . . .	200	300	300	volts
DC Grid-No.1 Voltage <sup>u</sup> . . . . .	-35	-30	-22	volts
DC Plate Current. . . . .	150	170	170	ma
DC Grid-No.2 Current. . . . .	5	1	1	ma
DC Grid-No.1 Current. . . . .	3	10	4	ma
Driver Power Output (Approx.) <sup>q</sup> . . . . .	3	3	5	watts
Useful Power Output (Approx.) . . . . .	23	80	40	watts

## Maximum Circuit Values:

Grid-No.1-Circuit Resistance  
under any condition . . . . . 30000<sup>r</sup> max. ohms

- <sup>a</sup> Because the cathode is subjected to considerable back bombardment as the frequency is increased with resultant increase in temperature, the heater voltage should be reduced depending on operating conditions and frequency to prevent overheating the cathode and resultant short life.
- <sup>b</sup> Measured with special shield adapter.
- <sup>c</sup> Subscript 1 indicates that grid-No.1 current does not flow during any part of the input cycle.
- <sup>d</sup> Continuous Commercial Service.
- <sup>e</sup> Averaged over any audio-frequency cycle of sine-wave form.
- <sup>f</sup> Preferably obtained from a fixed supply.
- <sup>g</sup> The driver stage should be capable of supplying the No.1 grids of the class AB<sub>1</sub> stage with the specified driving voltage at low distortion.
- <sup>h</sup> The resistance introduced into the grid-No.1 circuit by the input coupling should be held to a low value. In no case should it exceed the specified maximum value. Transformer- or impedance-coupling devices are recommended.
- <sup>j</sup> Subscript 2 indicates that grid-No.1 current flows during some part of the input cycle.
- <sup>k</sup> Driver stage should be capable of supplying the specified driving power at low distortion to the No.1 grids of the AB<sub>2</sub> stage. To minimize distortion, the effective resistance per grid-No.1 circuit of the AB<sub>2</sub> stage should be held at a low value. For this purpose, the use of transformer coupling is recommended.
- <sup>m</sup> "Single-Tone" operation refers to that class of amplifier service in which the grid-No.1 input consists of a monofrequency rf signal having constant amplitude. This signal is produced in a single-sideband suppressed-carrier system when a single audio frequency of constant amplitude is applied to the input of the system.
- <sup>n</sup> Obtained preferably from a separate source modulated along with the plate supply.
- <sup>p</sup> Obtained from grid-No.1 resistor or from a combination of grid-No.1 resistor with either fixed supply or cathode resistor.
- <sup>q</sup> The driver stage is required to supply tube losses and rf-circuit losses. It should be designed to provide an excess of power above the indicated values to take care of variations in line voltage, in components, in initial tube characteristics, and in tube characteristics during life.
- <sup>r</sup> If this value is insufficient to provide adequate bias, the additional required bias must be supplied by a cathode resistor or fixed supply.
- <sup>s</sup> Key-down conditions per tube without amplitude modulation. Amplitude modulation essentially negative may be used if the positive peak of the audio-frequency envelope does not exceed 115% of the carrier conditions.
- <sup>t</sup> Obtained preferably from a fixed supply, or from the plate-supply voltage with a voltage divider.
- <sup>u</sup> Obtained from fixed supply, by grid-No.1 resistor, by cathode resistor, or by combination methods.
- <sup>v</sup> See *Dimensional Outline* for temperature measurement points.



## CHARACTERISTICS RANGE VALUES

	Note	Min.	Max.	
Heater Current . . . . .	1	1.84	2.26	amp
Direct Interelectrode Capacitances:				
Grid No.1 to plate . . . . .	2	-	0.065	pf
Grid No.1 to cathode & heater . . . . .	2	11.8	15.2	pf
Plate to cathode & heater . . . . .	2	-	0.015	pf
→ Grid No.1 to grid No.2 . . . . .	2	15.9	19.2	pf
Grid No.2 to plate . . . . .	2	4.0	5.0	pf
Grid No.2 to cathode & heater . . . . .	2	-	0.40	pf
Grid-No.1 Voltage . . . . .	1,3	-6	-15	volts
Grid-No.1 Cutoff Voltage . . . . .	1,4	-	-30	volts
Grid-No.1 Current . . . . .	1,5	10	-	ma
Reverse Grid-No.1 Current . . . . .	1,3	-	-20	μa
Grid-No.2 Current . . . . .	1,3	-8	+2	ma
Peak Emission . . . . .	1,6	-	400	peak volts
Interelectrode Leakage Resistance . . . . .	7	1.0	-	megohm
Useful Power Output . . . . .	8	80	-	watts

Note 1: With 6.3 volts ac or dc on heater.

Note 2: Measured with special shield adapter.

Note 3: With dc plate voltage of 1000 volts, dc grid-No.2 voltage of 300 volts, and dc grid-No.1 voltage adjusted to give a dc plate current of 115 ma.

Note 4: With dc plate voltage of 1000 volts, dc grid-No.2 voltage of 250 volts, and dc grid-No.1 voltage adjusted to give a dc plate current of 1 ma.

Note 5: With plate and grid-No.2 floating and dc grid No.1 voltage of +2 volts.

Note 6: For conditions with: grid No.1, grid No.2, and plate tied together; and pulse voltage source connected between plate and cathode. Pulse duration is 2 microseconds, pulse repetition frequency is 60 pps, and duty factor is 0.00012. The voltage-pulse amplitude is adjusted until a peak cathode current of 10 amperes is obtained. After 1 minute at this value, the voltage-pulse amplitude will not exceed 400 volts (peak).

Note 7: Under conditions with tube at 20° to 30° C for at least 30 minutes without any voltages applied to the tube. The minimum resistance between any two adjacent electrodes as measured with a 200-volt Megger-type ohmmeter having an internal impedance of 1 megohm, will be 1 megohm.

→ Note 8: In a single-tube, grid-driven coaxial-cavity class C amplifier circuit at 400 Mc and for conditions with 5.7 volts ac or dc on heater, dc plate voltage of 1000 volts, dc grid-No.2 voltage of 300 volts, grid-No.1 resistor adjustable between 0 and 10000 ohms, dc plate current of 180 ma. maximum, dc grid-No.1 current of 30 ma. maximum, and driver power output of 3 watts.

→ Indicates a change.



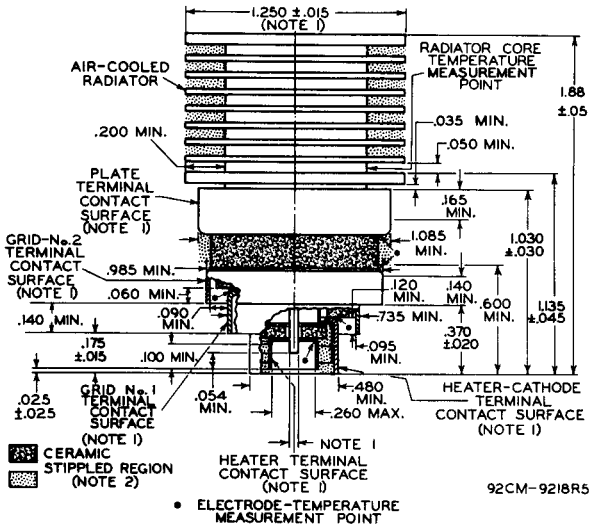

## DIMENSIONS IN INCHES

**Note 1:** With the cylindrical surfaces of the plate terminal, grid-No.2 terminal, grid-No.1 terminal, heater-cathode terminal, and heater terminal clean, smooth, and free of burrs, the tube will enter a gauge as shown in sketch G<sub>1</sub>. The tube is properly seated in the gauge when a 0.010" thickness gauge 1/8" wide will not enter between the heater-cathode terminal and the bottom surface of H<sub>4</sub>. The gauge is provided with a slot to permit making measurement of seating of heater-cathode terminal on bottom of hole H<sub>4</sub>.

**Note 2:** Keep all stiplled regions clear. Do not allow contacts or circuit components to protrude into these annular volumes.

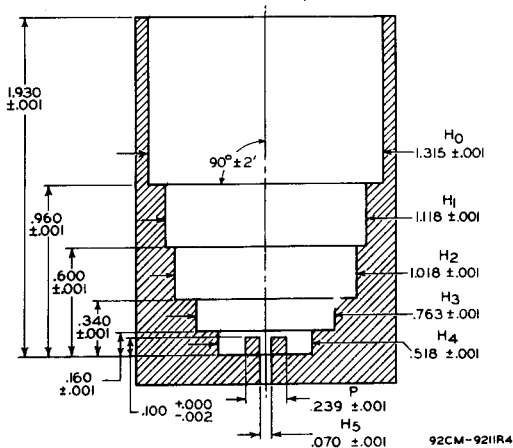

SKETCH G<sub>1</sub>

## DIMENSIONS IN INCHES

THE AXES OF THE CYLINDRICAL HOLES H<sub>0</sub> THROUGH H<sub>5</sub> AND THE AXIS OF POST P ARE COINCIDENT WITHIN 0.001".



SUGGESTED MOUNTING ARRANGEMENT  
& LAYOUT OF ASSOCIATED CONTACTS

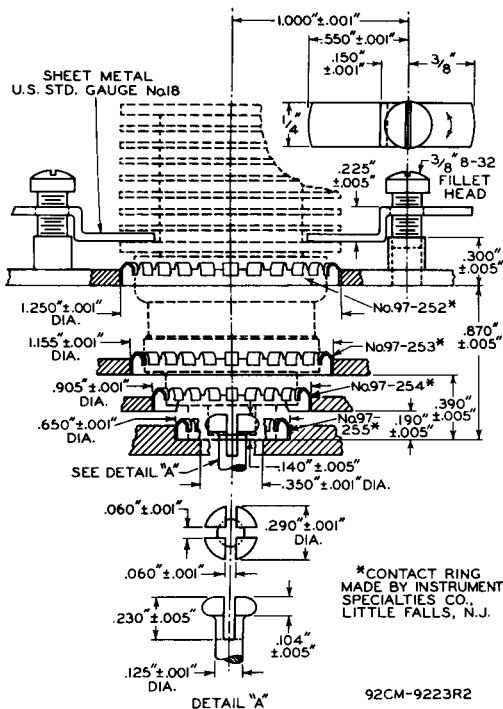

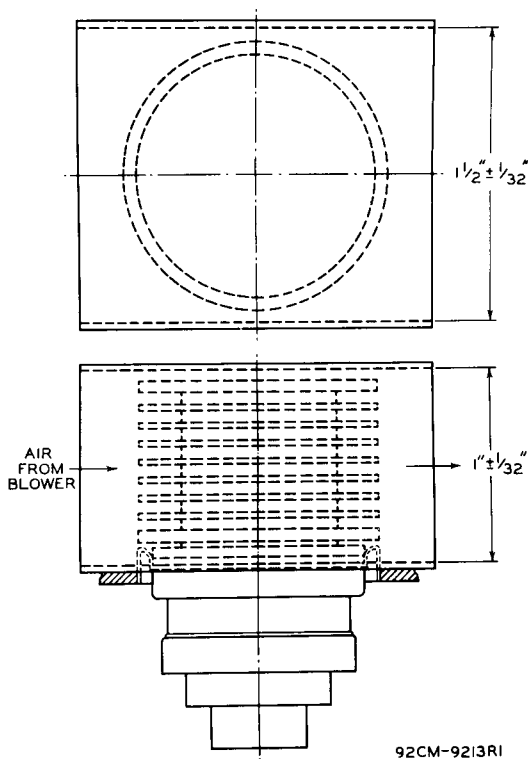
RECOMMENDED COWLING  
FOR DIRECTING AIR FLOW THROUGH RADIATOR

## TYPICAL COOLING REQUIREMENTS With Cowling

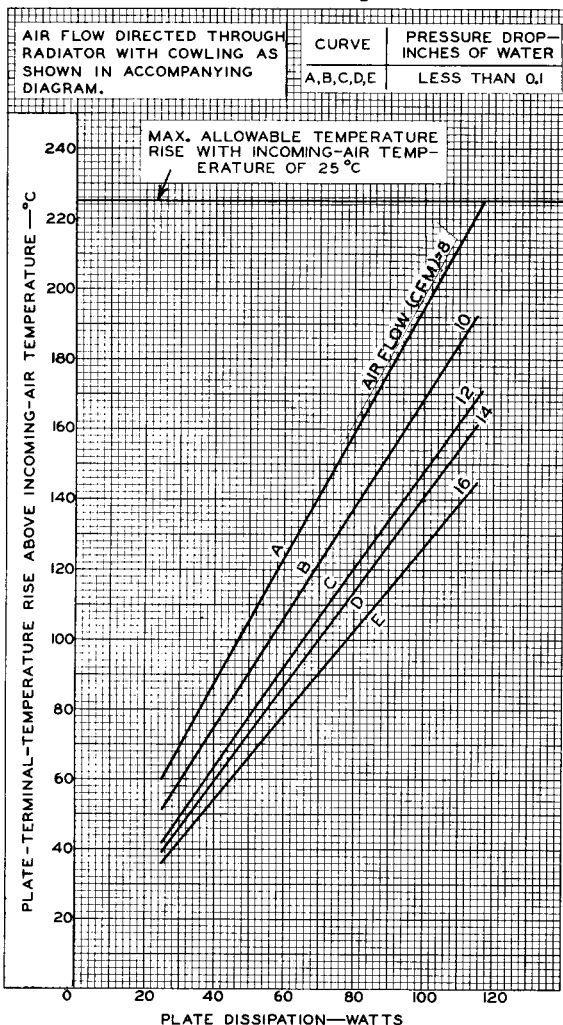

92CM-9219RI



## TYPICAL COOLING REQUIREMENTS Without Cowling

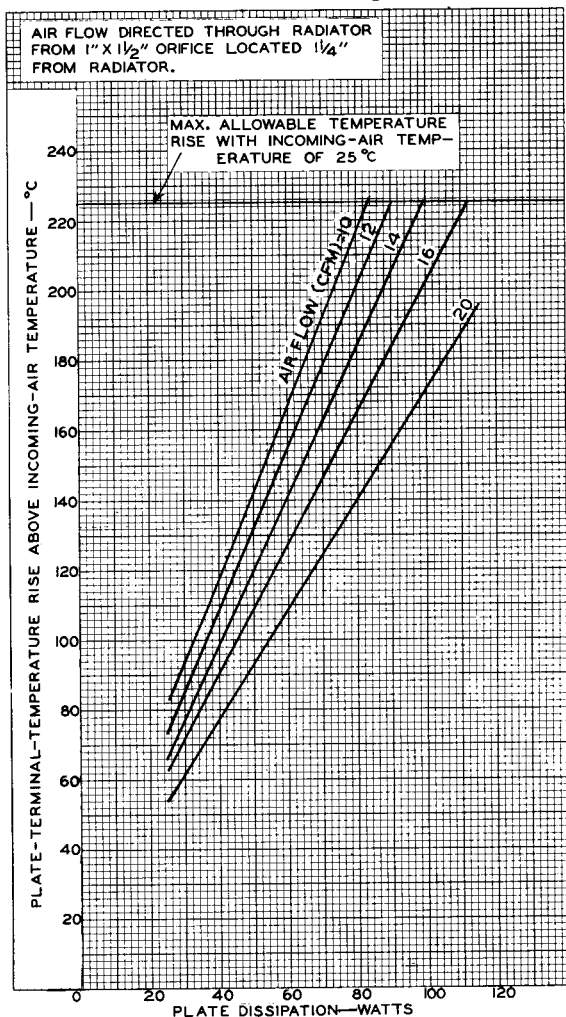

92CM-9220R1



## TYPICAL PLATE CHARACTERISTICS

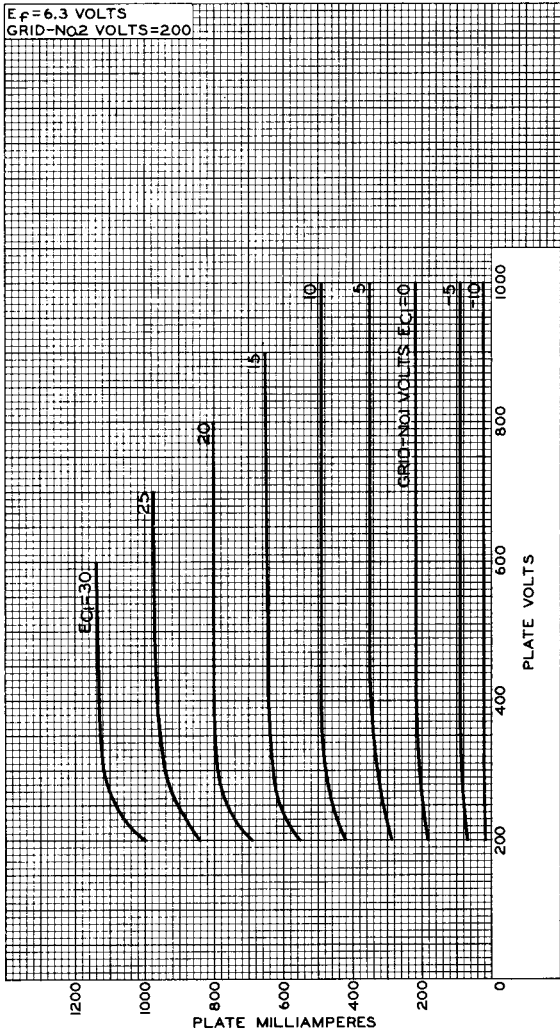

92CM-9228R2



## TYPICAL PLATE CHARACTERISTICS

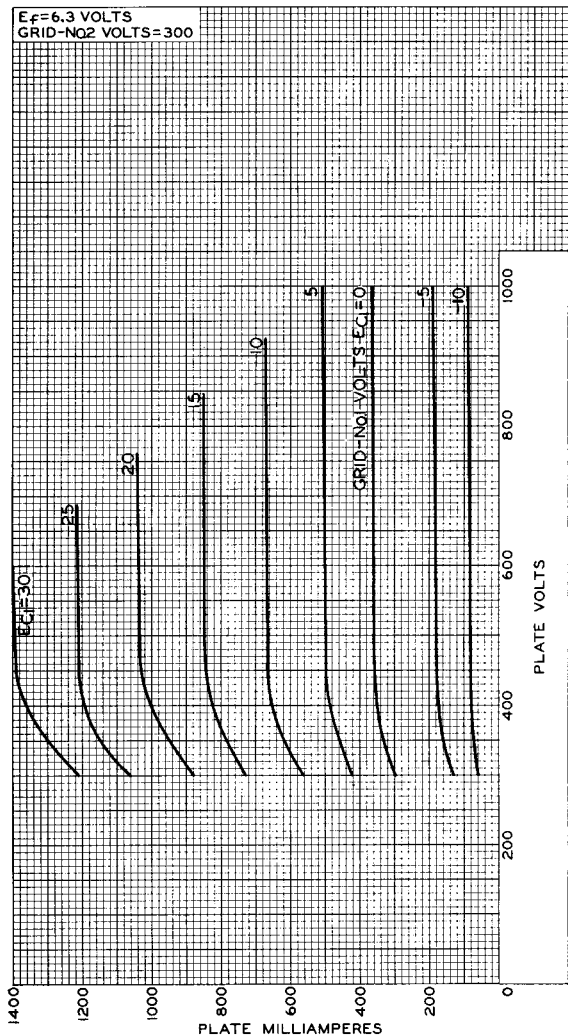

## TYPICAL CONSTANT-CURRENT CHARACTERISTICS

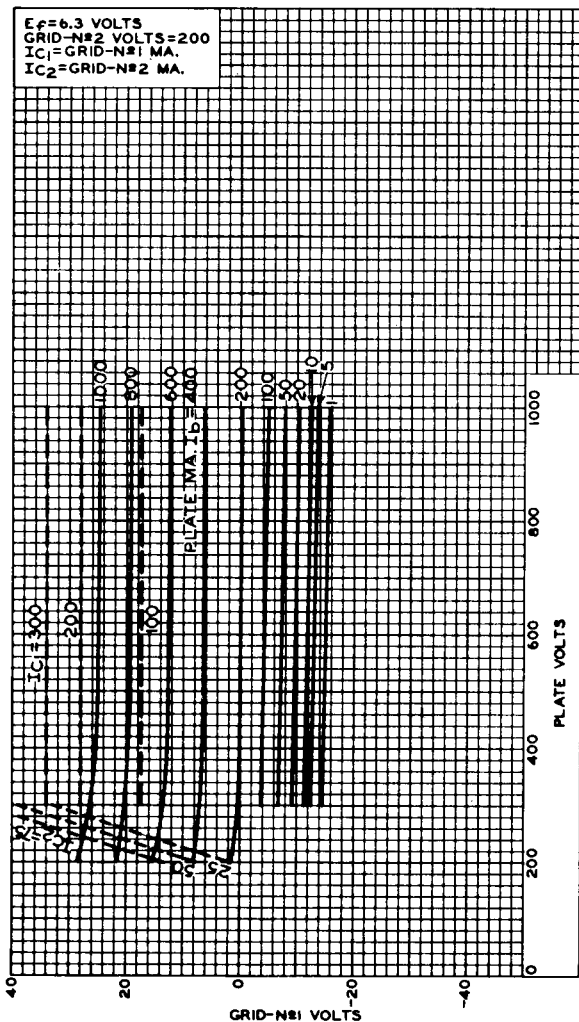

92CM-9233RI



## TYPICAL CONSTANT-CURRENT CHARACTERISTICS

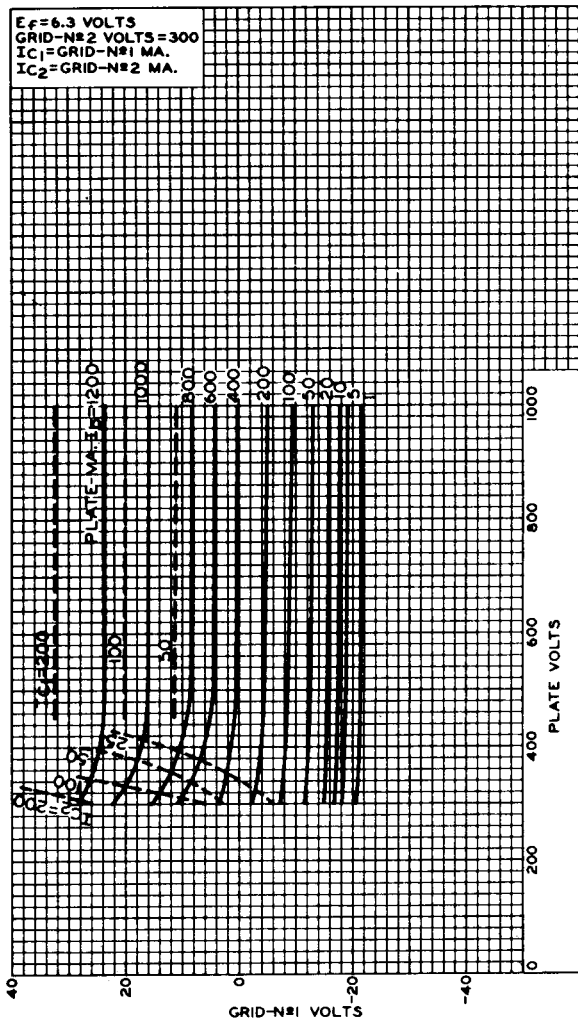

92CM-9232RI





## TYPICAL CHARACTERISTICS

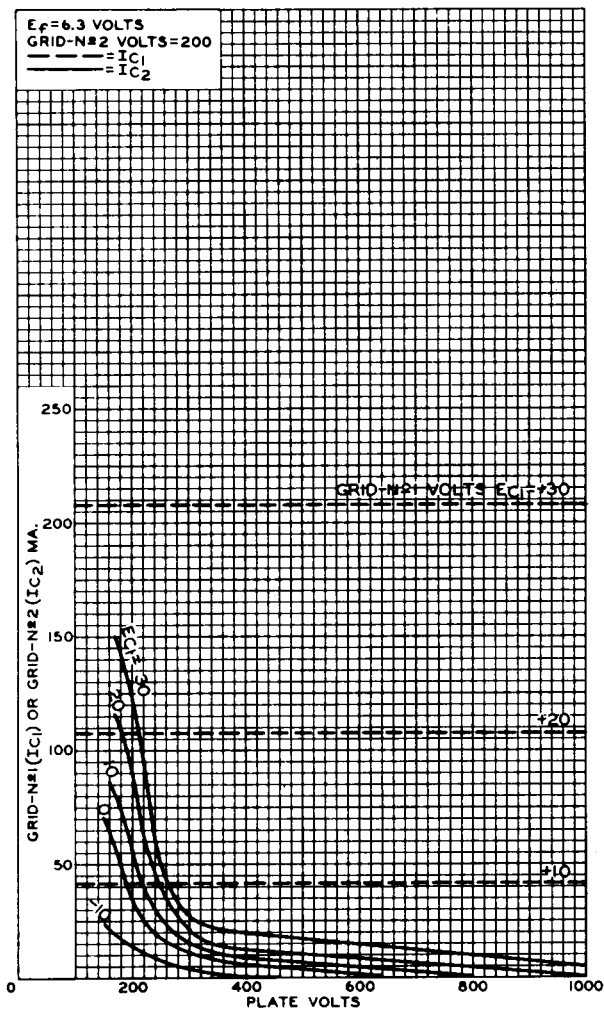

92CM-9224R1



## TYPICAL CHARACTERISTICS

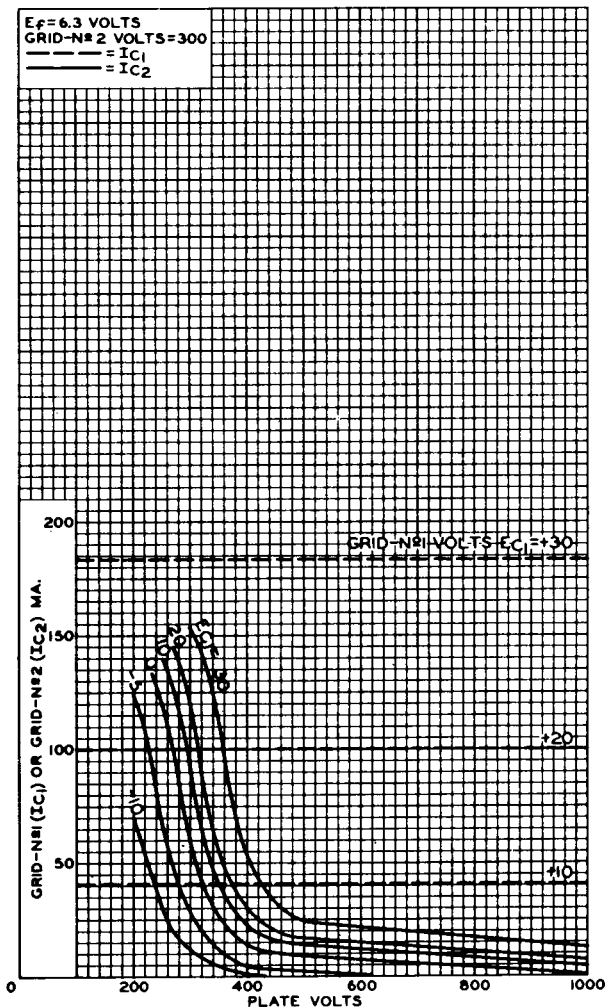

92CM-9225R2



## TYPICAL PERFORMANCE CHARACTERISTICS In Class C Telegraphy or Class C FM Telephony Amplifier Service

$E_f$  = ADJUSTED TO SIMULATE NORMAL OPERATING  
 CONDITIONS OF HEATER IN UHF SERVICE  
 PLATE VOLTS = 900  
 GRID-N $\times$ 2 VOLTS = 300  
 PLATE AMPERES = 0.170  
 OVERALL EFFICIENCY = USEFUL POWER OUTPUT IN LOAD  
 DIVIDED BY DC PLATE INPUT  
 POWER GAIN = USEFUL POWER OUTPUT IN LOAD  
 DIVIDED BY DRIVER POWER OUTPUT

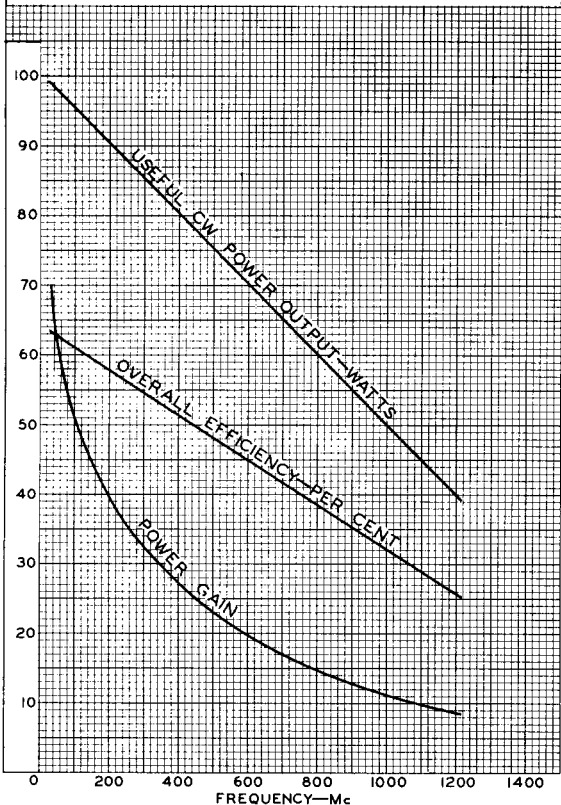

92CM-9221

