



5786

5786

POWER TRIODE

FORCED-AIR COOLED

GENERAL DATA

Electrical:

Filament, Thoriated-Tungsten:

Voltage 11 ± 0.6 ac or dc volts

Current 12.5 amp

Starting Current: The filament current must never exceed 50 amperes, even momentarily.

Cold Resistance 0.13 ohm

Amplification Factor 30

Direct Interelectrode Capacitances:

Grid to Plate 5.3 $\mu\mu\text{f}$

Grid to Filament 4.2 $\mu\mu\text{f}$

Plate to Filament 3.4 $\mu\mu\text{f}$

Mechanical:

Terminal Connections:

F—Filament

F_M—Filament
Mid-Tap

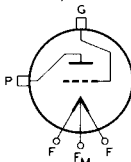

G—Grid

P—Radiator-
Cooled Plate

Mounting Position Vertical, grid end up or down

Overall Length 9-3/8" ± 1/4"

Maximum Diameter 2.895"

Radiator Integral part of tube

Air Flow:

To Radiator and Seals

for Maximum Rated Conditions . . 140 min. cfm

sufficient air must be delivered by a blower to the radiator and seals so that the maximum radiator and seal temperatures will not be exceeded. Air flow must start before the application of any voltages. Filament power, plate power, and air may be removed simultaneously.

Incoming Air Temperature 45 max. °C

Radiator Temperature (Measured at core at sufficient number of places to insure that rating is not exceeded) 180 max. °C

Seal Temperature:

Grid and Plate 165 max. °C

Filament 220 max. °C

Components:

Filament Transformer RCA-203T2

AF POWER AMPLIFIER & MODULATOR—Class B

Maximum CCS* Ratings, Absolute Values:

DC PLATE VOLTAGE 3000 max. volts

MAX.—SIGNAL DC PLATE CURRENT* 400 max. ma

MAX.—SIGNAL PLATE INPUT* 1200 max. watts

PLATE DISSIPATION* 600 max. watts

*: See next page.

5786



5786

POWER TRIODE

Typical Operation:*Values are for 2 tubes*

DC Plate Voltage	3000	volts
DC Grid Voltage*	-95	volts
Peak AF Grid-to-Grid Voltage	470	volts
Zero-Signal DC Plate Current	75	ma
Max.-Signal DC Plate Current	800	ma
Effective Load Resistance (Plate-to-plate)	8600	ohms
Max.-Signal Driving Power (Approx.)	30	watts
Max.-Signal Power Output (Approx.)	1640	watts

* Averaged over any audio-frequency cycle of sine-wave form.

Grid voltage is given with respect to mid-point of filament operated on ac or dc.

PLATE-MODULATED RF POWER AMPLIFIER - Class C Telephony*Carrier conditions per tube for use with a max. modulation factor of 1.0***Maximum CCS* Ratings, Absolute Values:**

DC PLATE VOLTAGE	2500 max.	volts
DC GRID VOLTAGE	-500 max.	volts
DC PLATE CURRENT	400 max.	ma
DC GRID CURRENT	150 max.	ma
PLATE INPUT	1000 max.	watts
PLATE DISSIPATION	400 max.	watts

Typical Operation:

DC Plate Voltage	2500	volts
DC Grid Voltage [Ⓜ]	{ -350 2600	volts ohms
Peak RF Grid Voltage	620	volts
DC Plate Current	400	ma
DC Grid Current (Approx.) [Ⓜ]	135	ma
Driving Power (Approx.) [Ⓜ]	75	watts
Power Output (Approx.)	810	watts

RF POWER AMPLIFIER & OSCILLATOR - Class C Telegraphy*Key-down conditions per tube without amplitude modulation[Ⓜ]***Maximum CCS* Ratings, Absolute Values:**

DC PLATE VOLTAGE	3000 max.	volts
DC GRID VOLTAGE	-500 max.	volts
DC PLATE CURRENT	500 max.	ma
DC GRID CURRENT	150 max.	ma
PLATE INPUT	1500 max.	watts
PLATE DISSIPATION	600 max.	watts

[Ⓜ] Modulation essentially negative may be used if the positive peak of the audio-frequency envelope does not exceed 115% of the carrier conditions.

•, € , Ⓜ : See next page.

FEB. 1, 1949

TUBE DEPARTMENT

TENTATIVE DATA 1

RADIO CORPORATION OF AMERICA, HARRISON, NEW JERSEY



5786

5786

POWER TRIODE**Typical Operation as RF Power Amplifier:**

DC Plate Voltage	3000	volts
DC Grid Voltage ^{▲▲}	-200	volts
	2200	ohms
	330	ohms
Peak RF Grid Voltage	450	volts
DC Plate Current	500	ma
DC Grid Current (Approx.) [□]	90	ma
Driving Power (Approx.) [□]	36	watts
Power Output (Approx.)	1000	watts

Typical Operation as Oscillator at 160 Mc:

DC Plate Voltage	3000	volts
DC Grid Voltage †	-225	volts
	2000	ohms
	380	ohms
Peak RF Grid Voltage	475	volts
DC Plate Current	500	ma
DC Grid Current (Approx.) [□]	90	ma
Power Output (Approx.)	1000	watts
Useful Power Output (Approx.)— 85% circuit efficiency	850	watts

▲▲ obtained from fixed supply, by grid resistor (2200) or by cathode resistor (330).

† obtained from fixed supply, by grid resistor (2000) or by cathode resistor (380).

SELF-RECTIFYING OSCILLATOR or AMPLIFIER—Class C**Maximum CCS[•] Ratings, Absolute Values:**

RMS PLATE VOLTAGE	4250 max.	volts
DC GRID VOLTAGE	-300 max.	volts
DC PLATE CURRENT	320 max.	ma
DC GRID CURRENT	85 max.	ma
PLATE INPUT	1500 max.	watts
PLATE DISSIPATION	600 max.	watts

Typical Operation:

RMS Plate Voltage	4250	volts
DC Grid Voltage [⊕]	-115	volts
	1500	ohms
DC Plate Current	320	ma
DC Grid Current [□]	77	ma
Driving Power (Approx.) ^{■□}	46	watts
Power Output (Approx.)	1050	watts

■ From a self-rectifying driver.

•, □, ⊕ : See next page.

5786



5786

POWER TRIODE

AMPLIFIER or OSCILLATOR—Class C

With Separate, Rectified, Unfiltered, Single-Phase,
Full-Wave Plate Supply

Maximum CCS* Ratings, Absolute Values:

DC PLATE VOLTAGE	2700 max.	volts
DC GRID VOLTAGE.	-300 max.	volts
DC PLATE CURRENT	450 max.	ma
DC GRID CURRENT.	120 max.	ma
PLATE INPUT.	1500 max.	watts
PLATE DISSIPATION.	600 max.	watts

Typical Operation:

DC Plate Voltage	2700	volts
DC Grid Voltage [†]	{ -180 1530	volts
		ohms
DC Plate Current	450	ma
DC Grid Current (Approx.) [□]	118	ma
Driving Power (Approx.) ^{▲ □}	57	watts
Power Output (Approx.)	1150	watts

* Continuous Commercial Service.

□ For effect of load resistance on grid current and driving power, refer to TUBE RATINGS—Grid Current and Driving Power in the General Section.

† Obtained by grid resistor of value shown or by partial self-bias methods.

▲ From a driver with a rectified, unfiltered, single-phase, full-wave plate supply.

CHARACTERISTICS RANGE VALUES FOR EQUIPMENT DESIGN

	<u>Note</u>	<u>Min.</u>	<u>Max.</u>	
Filament Current	1	11.7	13.3	amp
Amplification Factor	1, 2	27	33	
Grid-Plate Capacitance	-	4.8	5.8	μmf
Grid-Filament Capacitance.	-	3.6	4.8	μmf
Plate-Filament Capacitance	-	2.8	4.0	μmf
Plate Voltage.	1, 3	1030	1350	volts
Plate Voltage.	1, 4	2400	3000	volts
Grid Voltage	1, 5	-	-130	volts
Peak Cathode Current	1, 6	6	-	amp
Useful Power Output.	1, 7	800	-	watts

Note 1: With 11 volts ac on filament

Note 2: With dc grid voltage of -25 volts, and plate voltage adjusted to give dc plate current of 200 ma.

Note 3: With dc grid voltage of 0 volts, and plate voltage adjusted to give dc plate current of 200 ma.

Note 4: With dc grid voltage of -50 volts, and plate voltage adjusted to give dc plate current of 200 ma.

Note 5: With dc plate voltage of 3000 volts, and grid voltage adjusted to give a dc plate current of 1 ma.

Note 6: Represents the maximum usable cathode current (plate current and grid current) for the tube under any condition of operation.



5786

5786

POWER TRIODE

Note 7: With dc plate voltage of 3000 volts, dc plate current of 500 ma., dc grid current of 80 to 120 ma., grid resistor of $2000 \pm 10\%$ ohms, and frequency of 160 Mc.

Data on operating frequencies for the 5786 are given on the sheet TRANS. TUBE RATINGS vs FREQUENCY.

OPERATING NOTES

The quantity of air necessary for adequate cooling of the 5786 will depend on the power input to the tube, as well as on the efficiency and frequency at which the tube is operated. When the 5786 is operated with full power input at the maximum rated frequency of 160 megacycles, and with the circuit adjusted for tube operation at the maximum plate-dissipation rating, sufficient cooling will be provided by a blower such as the Fasco No. 50749. This blower is made by F. A. Smith Mfg. Co., Inc., Rochester 2, N. Y. It has an outlet area of approximately 6.25 square inches and is capable of supplying 140 cubic feet of air per minute, free delivery.

Provision must be made to direct part of the air from the blower to the filament and grid seals. For this purpose, a blower duct similar to that shown on the following sheet is suggested. Also sketched is a semi-circular air deflector which is useful in providing adequate cooling to the side of the grid seal away from the incoming air stream.

Depending on the type of application in which the 5786 is used, the required quantity of cooling air and the method employed for directing this air to the radiator and seals will vary considerably. It is recommended, therefore, that operating temperatures be measured in each application to make certain that maximum temperature ratings are not exceeded.

5786



5786

POWER TRIODE

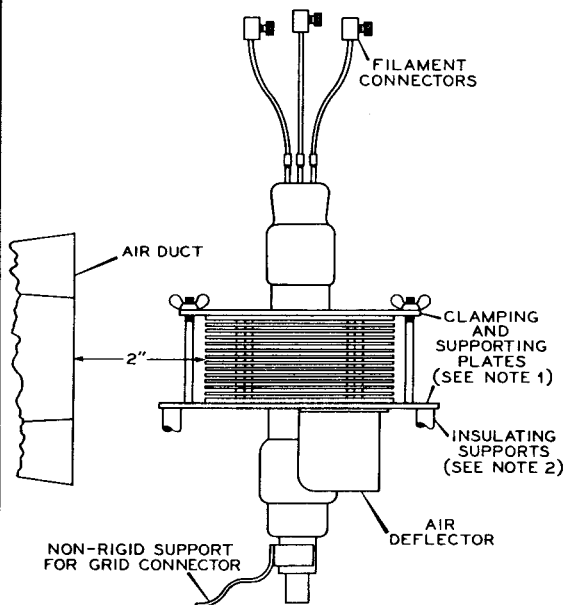
SUGGESTED MOUNTING

92CM-7080R1

NOTE 1: SUPPORTING PLATE AND CLAMPING PLATE HAVE HOLES LARGE ENOUGH TO PERMIT PASSAGE OF THE GLASS BULBS OF THE TUBE.

NOTE 2: TWO OR MORE INSULATORS MAY BE USED. INSULATORS MUST BE PLACED SO AS TO NOT INTEREFERE WITH AIR FLOW ONTO GRID TERMINAL.



5786

5786

POWER TRIODE

AIR DUCT

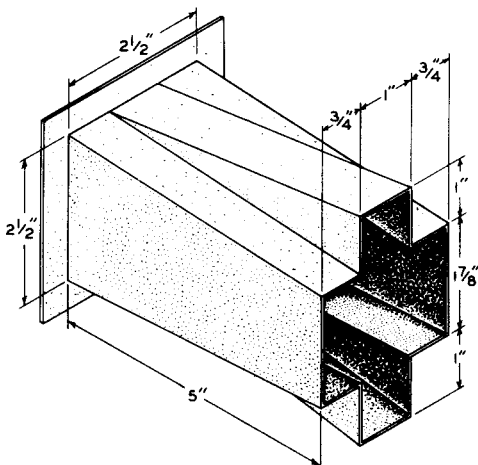

AIR DEFLECTOR

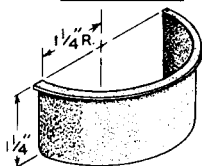

92CS-7117

5786



5786

POWER TRIODE

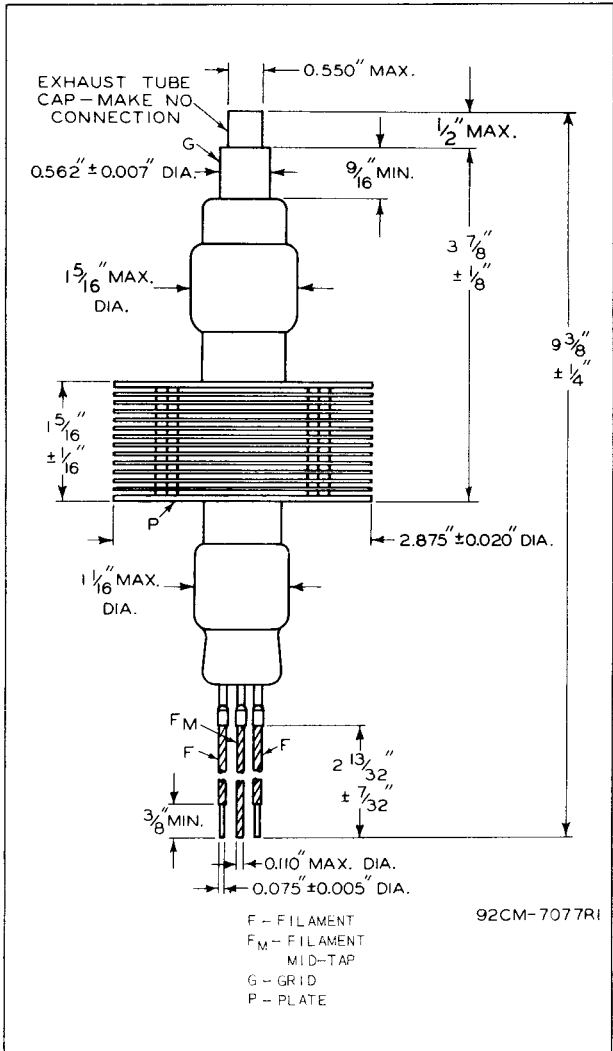

FEB. 1, 1949

TUBE DEPARTMENT

RADIO CORPORATION OF AMERICA, HARRISON, NEW JERSEY

CE-7077R1



5786

5786

AVERAGE PLATE CHARACTERISTICS

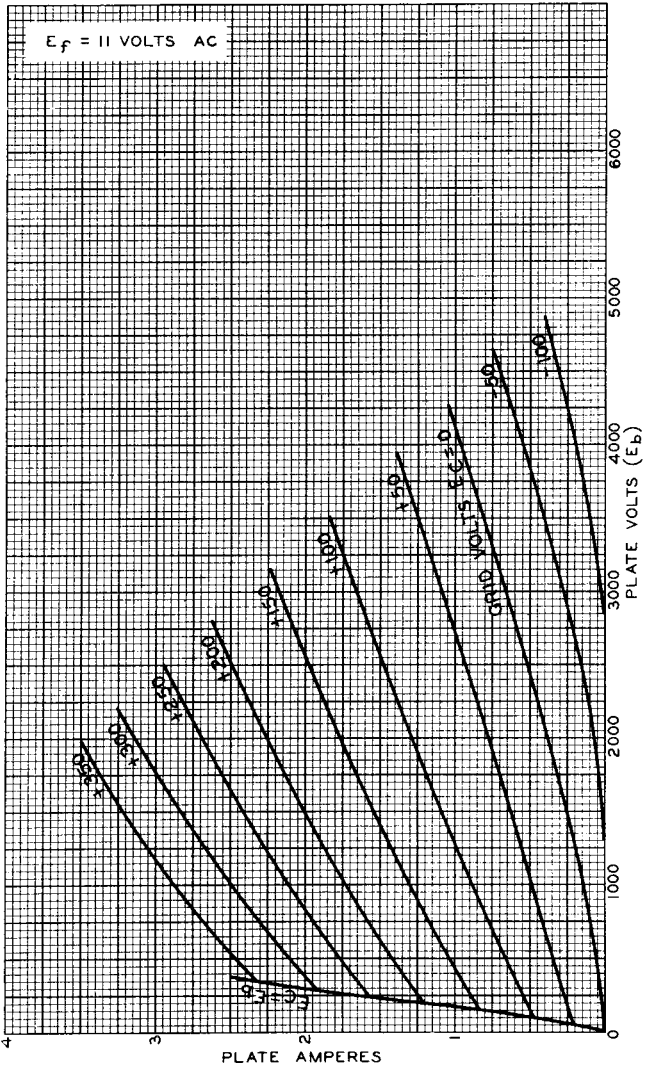

MAY 10, 1948

TUBE DEPARTMENT
RADIO CORPORATION OF AMERICA, HARRISON, NEW JERSEY

92CM-6593RI

5786



5786

TYPICAL CHARACTERISTICS

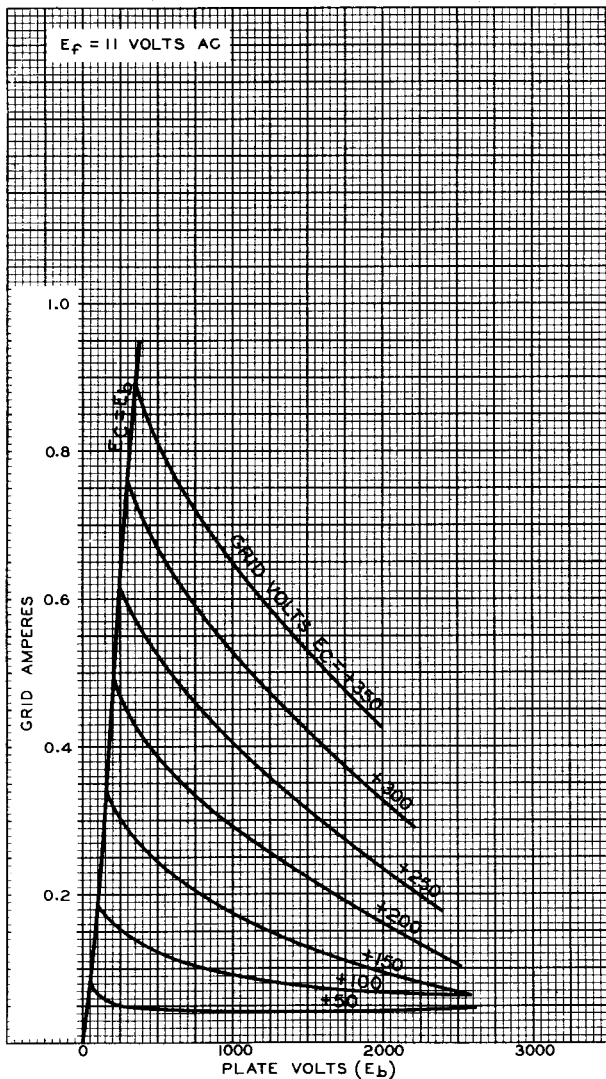

SEPT. 5, 1945

TUBE DEPARTMENT
RADIO CORPORATION OF AMERICA, HARRISON, NEW JERSEY

92CM-6594